

TECHNICAL MANUAL
FOR
VEGETABLE PEELERS
Model 30VP-2
Model 50VP-2

INSINGER MACHINE COMPANY
6245 STATE ROAD
PHILADELPHIA, PA 19135
1-800-344-4802

This page intentionally left blank.

Insinger 30VP and 50VP

REVISION RECORD

Date of original manual:

2 June 1995

SN 951021 and higher

<u>Rev.</u>	<u>Date</u>	<u>Effective Serial No.</u>	<u>Description</u>
A	9/20/05	050356	Reformatted and updated.

Insinger 30VP and 50VP

This page intentionally left blank

Insinger 30VP and 50VP

FACTORY SUPPORT

Insinger Machine Company:
6245 State Road
Philadelphia, PA 19135
800-344-4802
215-624-4800
215-624-6966 (Fax)
www.insingermachine.com

Please contact the factory for the name of your local Authorized Service Agency.

SAFETY SUMMARY

The following general safety notices supplement the specific warnings and cautions appearing in this manual:

All service except for routine shut-down procedures and operator's troubleshooting procedures must be performed by qualified maintenance personnel.

Prior to any work on this machine involving service of electrical systems, the machine and disposer (if provided) must be de-energized by turning the electrical supply power "Off".

The following is a summary of the warnings and cautions appearing in the text of this manual to alert personnel to potentially hazardous situations:

WARNINGS

Warning definition: A warning designates potential bodily harm if not followed.

Page 3-1: Do not place hands inside while machine is in operation.

Page 5-1: Prior to performing any electrical work on the VP series of vegetable peelers, the electrical supply service to the peeler and the electrical supply service to the optional disposer must be de-energized or disconnected.

Troubleshooting or repair of the electrical equipment should only be done by a qualified electrician.

Page 6-1: Always turn the power switch "Off" prior to working on the disposer. However, for increased safety, NEVER put hands or fingers into the disposer. Use tongs to remove foreign objects.

Page 6-2: Prior to performing any electrical work on the VP series of vegetable peelers, the electrical supply service to the peeler and the electrical supply service to the optional disposer must be de-energized or disconnected.

Troubleshooting or repair of the electrical equipment should only be done by a qualified electrician.

Insinger 30VP and 50VP

Page 8-1: All portions of the installation must comply with applicable local regulations, codes, and requirements.

Page 8-2: All work should be done by a qualified electrician. All motor services must be grounded.

CAUTIONS

Caution definition: a caution designates potential equipment harm if not followed.

Page 3-1: The operator should become thoroughly familiar with the equipment and these operating instructions prior to starting the machine.

Page 3-2: The optional front casters must be locked whenever the peeler is operated.

Page 8-2: The four flanged legs of the vegetable peeler should be bolted to the floor. The optional front casters on selected units must be locked whenever the peeler is operated.

TABLE OF CONTENTS

<u>Section</u>	<u>Page</u>
1.0 GENERAL INFORMATION	
1.1 Introduction	1-1
1.2 Scope of the Manual	1-1
1.3 Equipment Description	1-1
1.4 Equipment Supplied	1-1
1.5 Limited Warranty	1-3
2.0 FUNCTIONAL DESCRIPTION	2-1
3.0 OPERATION	
3.1 Introduction	3-1
3.2 Controls and Indicators	3-1
3.3 Start-Up Procedure	3-2
3.4 Shut-Down Procedure	3-2
3.5 Guidelines for Peeling Potatoes	3-3
4.0 SCHEDULED MAINTENANCE	
4.1 Introduction	4-1
4.2 Monthly Requirements for Inspection and Maintenance	4-1
5.0 TROUBLESHOOTING	5-1
6.0 CORRECTIVE MAINTENANCE	
6.1 Introduction	6-1
6.2 Maintenance and Repair Procedures	
6.2.1 Clearing Jams in the Peeler	6-1
6.2.2 Clearing Jams in the Disposer	6-1

Insinger 30VP and 50VP

6.2.3	Replace Drive Motor.	6-2
7.0	PARTS LIST	
7.1	Introduction	7-1
7.2	Parts Procurement	7-1
7.3	Recommended Spare Parts	7-1
8.0	INSTALLATION	
8.1	Unpacking	8-1
8.2	Installation	
8.2.1	Mechanical and Piping	8-1
8.2.2	Electrical	8-2
8.2.3	Check-Out of the Installation	8-3

LIST OF TABLES

<u>Number</u>	<u>Title</u>	<u>Page</u>
1-1	Data Characteristics	1-2
5-1	Operator's Troubleshooting Guide	5-2
5-2	Maintenance Troubleshooting Guide	5-3

LIST OF ILLUSTRATIONS

7-1	Parts List - Basic Units	7-3
7-2	Parts List - Units with Front Scrap Drawer	7-4
7-3	Parts List - Units with Front Scrap Drawer, Casters, Special Chute Height	7-5
8-1	Installation - Basic Units	8-4
8-2	Installation - Front Scrap Drawer	8-5
8-3	Installation - Front Scrap Drawer, Casters, Special Chute Height	8-6
8-4	Electrical Wiring Schematics	8-7

CHAPTER 1

1.0 GENERAL INFORMATION

1.1 INTRODUCTION

This technical manual provides information for the installation, operation, inspection and maintenance of the VP series of vegetable peelers manufactured by the Insinger Machine Company, Philadelphia, PA.

1.2 SCOPE OF THE MANUAL

Chapters 1, 2, 3, and 8 provide information required for start-up, operation, and installation of the machines. Chapters 4, 5, 6 and 7 provide information on maintenance operations.

1.3 EQUIPMENT DESCRIPTION

The VP series of vegetable peelers are top loading, motor driven, stand alone units used for the peeling of hard vegetables, primarily potatoes.

1.4 EQUIPMENT SUPPLIED

Model	Capacity	Motor
30VP-2	30 lbs in 45 sec.	3/4 hp
50VP-2	50 lbs in one minute	1 hp

Insinger 30VP and 50VP

TABLE 1-1

DATA CHARACTERISTICS

Manufacturer:

Insinger Machine Company, Philadelphia, PA

Fresh Water Requirements:

Rated flow: 1.0 gpm at 20 - 50 psig.
Ambient (cold) water temperature.
1/4" IPS connection through the vacuum breaker.

Supply temperature: Cold (50 - 90° F).

Drain:

2" IPS below machine or
1-1/2" slip joint on optional disposer.

Electrical Power Requirements:

Nominal voltage	Operating Current (amps)		
	30VP-2 (3/4 hp)	50VP-2 (1 hp)	Disposer (3/4 hp).
120/1/60	13.8	16.0	8.1
240/1/60	6.9	8.0	N/A
208/3/60	3.5	4.6	N/A
230/3/60	3.2	4.2	N/A
380/3/50	1.9	2.5	N/A
460/3/60	1.6	2.1	N/A

Shipping Weight: 242 lbs 262 lbs add 18 lbs

Operating Weight: 227 lbs 247 lbs add 18 lbs

Insinger 30VP and 50VP

1.5 LIMITED WARRANTY

Insinger Machine Company, Inc. (Insinger) hereby warrants to the original retail purchaser of this Insinger Machine Company, Inc. product, that if it is assembled and operated in accordance with the printed instructions accompanying it, then for a period of either 15 months from the date of shipment from Insinger or 1 year (12 months) from the date of installation, that said Insinger product shall be free from defects in material and workmanship. Whichever one of the two aforestated limited warranty time periods is the longest shall be the applicable limited warranty coverage time period.

Insinger may require reasonable proof of your date of purchase, therefore, you should retain your copy of invoice or shipping document.

This limited warranty shall be limited to the repair or replacement of parts which prove defective under normal use and service and which on examination shall indicate, to Insinger's satisfaction, they are defective. Any part that is claimed to be defective and covered by this limited warranty must be returned to Insinger, this may be done through an Authorized Service Agency. Furnish serial number of machine with shipment and send to:

Insinger Machine Company, Inc.
6245 State Road
Philadelphia, PA 19135-2996

If Insinger's inspection confirms the defect and the claim, Insinger will repair or replace such part without charge and return it to you freight or postage prepaid.

This limited warranty does not cover any failure or accident, abuse, misuse, alteration, misapplication, improper installation, fire, flood, acts of God or improper maintenance or service, or failure to perform normal and routine maintenance as set out in the instruction booklet (operating instructions) or for improper operation or failure to follow normal operating instructions (as set out in the instruction booklet).

Insinger is not responsible nor liable for any conditions of erosion or corrosion caused by corrosive detergents, acids, lye or other chemicals used in the washing and or cleaning process.

Insinger 30VP and 50VP

Service must be done by either Insinger Appointed Service Agencies or agencies receiving prior authorization from Insinger. All warranty work must be done during normal working hours, unless purchaser receives prior authorization from Insinger.

There are no other express warrants except as set forth herein and any applicable implied warranties of merchantability and fitness are limited in duration to the period of coverage of this express written limited warranty. This limited warranty supersedes all other express warranties, implied warranties of merchantability and fitness or limited warranties as the above date. Some states do not allow limitation on how long an implied warranty lasts so this limitation may not apply to you.

Insinger is not liable for any special, indirect or consequential damages. Some states do not allow the exclusion or limitation of incidental or consequential damages, so this limitation nor exclusion may not apply to you.

Insinger does not authorize any person or company to assume for it any other obligation or liability in connection with the sale, installation, use, removal, return or replacement of its equipment; and no such representations are binding on Insinger.

Insinger 30VP and 50VP

CHAPTER 2

FUNCTIONAL DESCRIPTION

The VP series of vegetable peelers consist of base unit with abrasive disk drive system, a hopper, discharge chute with door, and hopper cover. An optional disposer and/or scrap drawer can be supplied on select models.

Vegetables, most commonly potatoes, are loaded into the hopper through an opening in the hopper cover. The abrasive disk rotates during this loading, and a small flow of water enters the hopper. The vegetables are tumbled by the action of the disk, and skin is removed as the vegetables grate against the abrasive surfaces of the disk and hopper. The removed peel is flushed by the water from the interior of the hopper to a drain tube, which may end in a peel trap, a scrap drawer, or a disposer.

A chute mounted on the side of the hopper allows the peeled vegetables to be discharged when peeling is completed and the chute door is opened.

Overload protection for the drive motor is included in the motor switch. The optional disposer is thermally protected against overload.

Insinger 30VP and 50VP

This page intentionally left blank

CHAPTER 3

3.0 OPERATION

3.1 INTRODUCTION

The VP series of vegetable peelers are heavy duty machines designed for daily use in a kitchen environment.

WARNING

Do not place hands inside while machine is in operation.

CAUTION

The operator should become thoroughly familiar with the equipment and these operating instructions prior to starting the machine.

3.2 CONTROLS AND INDICATORS

3.2.1 Toggle switch (single phase) or stop/start pushbutton (three phase) controls operation of drive motor.

3.2.2 Toggle switch controls operation of optional disposer.

3.2.3 Timer (optional) controls the running time of the drive motor.

3.3 START-UP PROCEDURE

3.3.1 Before starting the machine, inspect the inside and make sure that:

1. The rotating abrasive disk is in place, over the pin in the drive shaft.
2. The discharge chute door is closed and latched.

Insinger 30VP and 50VP

3. The hopper cover is in place.
4. The optional scrap drawer is pushed all the way into the machine.
5. The optional front casters are locked.

CAUTION

The optional front casters must be locked whenever the peeler is operated.

3.3.2 Open the cold water supply to the vacuum breaker. Only a gentle finger size flow, sufficient to flush away peels, is needed.

3.3.3 Start the drive motor and optional disposer.

NOTE

With the optional timer, first turn the timer knob clockwise to the desired time. Allow sufficient time for peeling and unloading (see 3.3.6). Then start the motor. Motor will stop at end of the timed period.

3.3.4 Slowly feed the vegetables to be peeled into the hopper through the opening in the hopper cover.

3.3.5 Allow 45 to 60 sec. for peeling. Time will vary according to type of vegetables and degree of peeling desired.

3.3.6 When peeling is complete, with the drive motor and optional disposer still operating, and with the cold water supply ON, open the door on the discharge chute. Vegetables will automatically empty from the hopper.

3.3.7 Inspect and empty, if necessary, the peel trap or optional scrap drawer.

Insinger 30VP and 50VP

3.4 SHUT-DOWN PROCEDURE

- 3.4.1 The machine should be cleaned at the end of each use.
- 3.4.2 Turn the drive and optional disposer switches Off.
- 3.4.3 Turn the cold water flow to the vacuum breaker Off.
- 3.4.4 Remove the abrasive disk by lifting straight upward.
- 3.4.5 Scrub all abrasive surfaces with a stiff fiber brush.
- 3.5.6 Flush the inside of the hopper, the hopper cover, the abrasive disk, and the peel trap.
- 3.4.7 If equipped with an optional scrap drawer, flush the drawer. Remove the drawer and flush the inside of the drawer chamber.
- 3.4.8 Replace all removed parts in reverse order.

3.4 GUIDELINES FOR PEELING POTATOES

- 3.4.1 Do not exceed the capacity - 30 or 50 lbs. - of the peeler.
- 3.4.2 Best results will be obtained when using US Grade #1 potatoes. Avoid irregular sizes and shapes. Peeling times may vary based on the age ("new" vs. "old") of the potatoes.
- 3.4.3 Start the abrasive disk, optional disposer, and cold water flow before feeding potatoes.
- 3.4.4 Do not overpeel. Stop when most of the skin is removed, but do not attempt to clean low spots or remove eyes.
- 3.4.5 Potato peels contain starch, which may cause foaming in the peel trap or optional scrap drawer. If foaming is excessive, stop the peeling to allow the foam to subside, or use smaller batches.

Insinger 30VP and 50VP

This page intentionally left blank

CHAPTER 4

SCHEDULED MAINTENANCE

4.1 INTRODUCTION

The VP series of vegetable peelers are rugged and simple machines. The scheduled maintenance described in this chapter is mostly a periodic set of inspections and cleaning.

4.2 MONTHLY REQUIREMENTS FOR INSPECTION AND MAINTENANCE

4.2.1 Inspect drive belt.

Remove the access cover on the front of the base unit. Check the V-belt for wear or signs of separation. Replace the belt if necessary.

4.2.2 Check drive belt tension.

Belt should deflect about 3/8" when subjected to a force of approximately 2 lbs. To adjust, loosen the 4 mounting nuts and bolts and slide motor away from the drive spindle to tighten the belt. Re-tighten the nuts.

4.2.3 Lubrication.

All bearings are pre-greased and sealed. No lubrication is required.

Insinger 30VP and 50VP

This page intentionally left blank

CHAPTER 5

TROUBLESHOOTING

This chapter contains information to assist the operator and/or maintenance personnel in troubleshooting abnormal operation.

The following tables list the more common symptoms which may be experienced, their causes, and the recommended corrective action. The tables are separated into operator and maintenance actions.

WARNING

Prior to performing any electrical work on the VP series of vegetable peelers, the electrical supply service to the peeler and the electrical supply service to the optional disposer must be de-energized or disconnected.

Troubleshooting or repair of the electrical equipment should only be done by a qualified electrician.

TABLE 5-1

OPERATOR'S TROUBLESHOOTING GUIDE

NOTE

This section covers actions that can be performed by the operator, without the use of tools.

SYMPTOM OF TROUBLE	POSSIBLE CAUSE	SOLUTION
1. Machine will not operate.	a. No power.	a. Move main power switch to ON.
2. Disposer will not operate.	a. Overload trip due to jam.	a. Clear jam. See 6.2.2.
3. Noise from inside of hopper.	a. Foreign object. b. Abrasive disk not seated on drive shaft pin.	a. Remove object. See 6.6.1. b. Seat slot in disk hub over drive shaft pin.
4. Disk does not turn when motor switch turned on.	a. Jam or obstruction.	a. Clear jam per 6.2.1.
5. Water leaks from optional scrap drawer.	a. Obstruction in drain. b. Full drawer or clogged drawer perforations.	a. Remove obstruction. b. Empty drawer or clean inside of drawer.
6. Water leaks from discharge chute door.	a. Door is not latched. b. Dirt on gasket surfaces.	a. Latch door. b. Clean gasket surfaces.
7. Potatoes not peeled within prescribed time.	a. Hopper overloaded. b. Potatoes of irregular size & shape. c. Abrasive surfaces dirty. d. Surfaces worn.	a. Reduce loading. b. US Grade #1 preferred. c. Clean surfaces with brush. d. Replace.

TABLE 5-2

MAINTENANCE TROUBLESHOOTING GUIDE

NOTE

This section covers actions that should be performed by qualified maintenance personnel.

SYMPTOM OF TROUBLE	POSSIBLE CAUSE	SOLUTION
1. Machine will not operate.	a. No power. b. Blown fuse/ breaker. c. Power shut off at disconnect switch. d. Motor overload protection tripped. e. Defective switch.	a. Check power supply. b. Replace fuse; reset breaker and troubleshoot source of problem. c. Move disconnect switch to ON. d. Reset overload. If motor overload trips repeatedly, check overload setting and motor current. e. Replace switch.
2. Machine vibrates.	a. Worn motor bearings.	a. Replace motor.
3. Disk does not turn when motor switch turned on.	a. Drive belt broken or loose. b. Loose set screws on pulleys.	a. Replace or tighten. b. Tighten screws.

Insinger 30VP and 50VP

This page intentionally left blank

CHAPTER 6.0

CORRECTIVE MAINTENANCE

6.1 INTRODUCTION

This chapter contains instructions for maintenance and replacement of components that can be damaged or fail in normal operation.

6.2 MAINTENANCE AND REPAIR PROCEDURES

6.2.1 Clearing jams in the peeler.

6.2.1.1 Turn the drive motor power switch "Off".

6.2.1.2 Inspect the inside of the hopper for items jammed between the abrasive disk and hopper wall. Rotate the disk by hand to "feel" for jams.

6.2.1.3 Remove the abrasive disk by pulling straight up with the center handle of the disk. Inspect the area below the disk for foreign objects.

6.2.1.4 Replace the abrasive disk, making sure that the slot in the disk hub engages the pin on the drive shaft.

6.2.2 Clearing jams in the disposer.

6.2.2.1 The disposer will not jam in normal use, since it processes soft peels. A jam will most likely be due to a foreign object.

6.2.2.2 Turn the cold water "Off" and turn the disposer power switch "Off". Inspect the inside of the disposer for foreign objects and remove same with tongs.

WARNING

Always turn the power switch "Off" prior to working on the disposer. However, for increased safety, NEVER put hands or fingers into the disposer. Use tongs to remove foreign objects.

Insinger 30VP and 50VP

6.2.2.3 Insert one end of the service wrench (provided with the disposer) into the center hole on the bottom of the disposer. Work the wrench back and forth until the disposer rotor moves freely for a complete revolution. Severe jams may require the use of a pry bar. Remove any foreign object with tongs.

6.2.3 Replace drive motor.

WARNING

Prior to performing any electrical work on the VP series of vegetable peelers, the electrical supply service to the peeler and the electrical supply service to the optional disposer must be de-energized or disconnected.

Troubleshooting or repair of the electrical equipment should only be done by a qualified electrician.

6.2.3.1 Turn the drive motor power switch "Off".

6.2.3.2 Remove the front access panel. Disconnect the power wires from the motor at the motor junction box.

6.2.3.3 Loosen the four motor mounting bolts and remove the V belt. Remove the bolts and the motor.

6.2.3.4 Remove the V belt pulley from the old motor shaft and place on the new motor shaft. Tighten set screws.

6.2.3.5 Install the new motor and V belt and align the motor pulley with the spindle pulley.

6.2.3.6 Tighten the V belt. Belt should deflect about 3/8" when subjected to a force of approximately 2 lbs. Slide the motor away from the drive spindle to tighten the belt. Retighten the nuts.

Insinger 30VP and 50VP

CHAPTER 7.0

PARTS LIST

7.1 INTRODUCTION

This chapter lists replaceable parts, referenced to part breakdown drawings.

No listing has been provided for parts of permanently assembled items, or for those items which are not suited to field replacement.

7.2 PARTS PROCUREMENT

All parts are available from the Insinger Machine Company, Philadelphia, Pennsylvania 19135.

7.3 RECOMMENDED SPARE PARTS

Item	PN	Description	Qty	Rec. Spares
1		Motor	1	1
	D2467-FL1B-1BM	3/4 Hp, 115/208-230, 1/60		
	D2467-FN1A-1BA	3/4 Hp, 110-220, 1/50		
	D2467-FF3B-1BA	3/4 Hp, 208-230/460, 3/60		
	D2467-GL1B-1BM	1 Hp, 115/208-230, 1/60		
	D2467-GF3B-1BA	1 Hp, 208-230/460, 3/60		
2	DE1-100	Motor switch (single ph)	1	1
		Motor switch (3 phase)	1	1
	DE2-80 series	Order by hp, phase and voltage		
3	D2242A	Vacuum breaker repair kit		1
4	D2459	V belt	1	1

Insinger 30VP and 50VP

This page intentionally left blank

Fig. 7-1

ITEM NO.	PART NO.	PART NAME	REQD.
1	974-99	ABRASIVE DISC	1
2	D2434	BEARINGS	2
3	974-20	BRACKET	1
4	974-24	CYLINDER COVER	1
5	974-66	CYLINDER	1
6	974-13	ACCESS DOOR	1
7	974-10A	CYLINDER DOOR	1
8	952-97	DRAIN FLANGE	1
9	D2435	ADJUSTABLE FOOT	4
10	952-89	GASKET, DRAIN	1
11	974-33	HANDLE, CYLINDER DOOR	1
12	974-30	HANDLE, SCRAP BASKET	1
13	974-12	HINGE PIN	1
14	D2464	MOTOR 3/4 HP (30HP)	1
15	974-83	CHUTE ASSEMBLY	1
16	D2-540	OIL SEAL	1
17	D2242A	POCKET DISC, VACUUM BREAKER	1
18	D2416	PULLEY 2.75 O.D.	1
19	D2437	PULLEY 15.3 O.D.	1
20	B-100	RETAINING RING	1
21	974-17	SCRAP BASKET	1
22	974-18	SCRAP TANK	1
23	974-29	SPACER	1
24	974-7	SPINDLE	1
25	DE5-15	SWITCH, TORQUE	1
26	D2489	1/2" BELT 4L520	1
27	D2436A	VACUUM BREAKER 1/4 IPS	1
28	974-64	GASKET	1
29	Q312C-EF-5	SEAL NUT #10-32	8
30	974-59	SPINDLE PIN	1
31	974-50	UPPER TROUGH BRACKET	1
32	974-53	LOWER TROUGH BRACKET	1
33	974-14	DISPOSER TROUGH	1
34	D2460	DISPOSER, 3/4 HP	1
35	1533-21	COVER LATCH ASSY	2

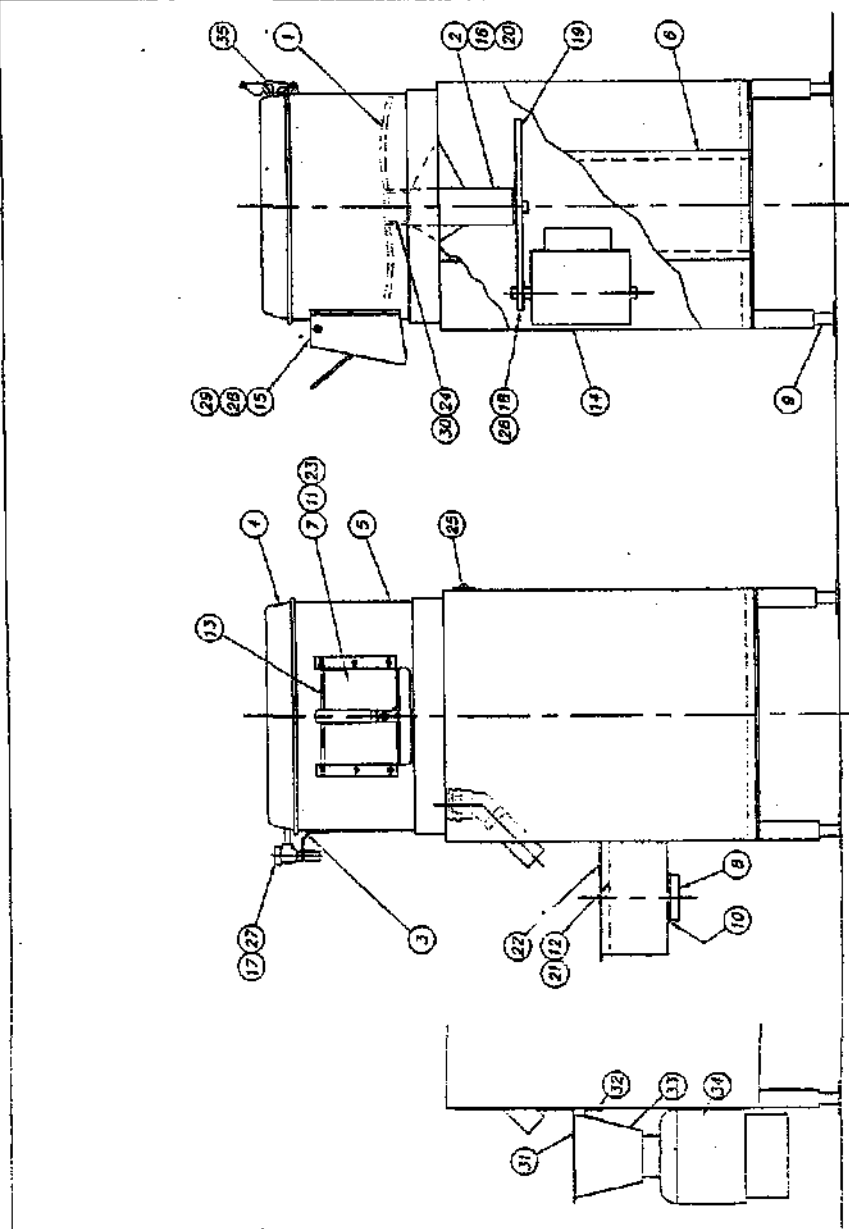

* = 974-66: FOR 30 HP
 † = 974-66B FOR 50 HP
 + = D2464A - 1 HP FOR 50 HP
 (SPECIFY VOLTAGE CYCLE & PHASE)

RIGHT SIDE

FRONT

OPTIONAL DISPOSER

TOLERANCES	DATE	FILE	REV	BY	LECN	NO	DATE	OR	OTHERWISE	UNLESS	ANGLES	± 1/2"	± .01	± .005	DECIMALS	1/8"	1/16"	1/32"			
	8/14/92		1				8/14/92														
	8/14/95		2				8/14/95														

TITLE	30HP & 50HP PARTS LIST	DWG. NO.	SK-2702
MATERIAL		REVISION	USED ON 30HP/50HP
		SCALE	1-10
		DATE	DRWN/DATE
		Philadelphia, PA 19135 (215) 624-4000 FAX (215) 624-6968	

Fig. 7-2

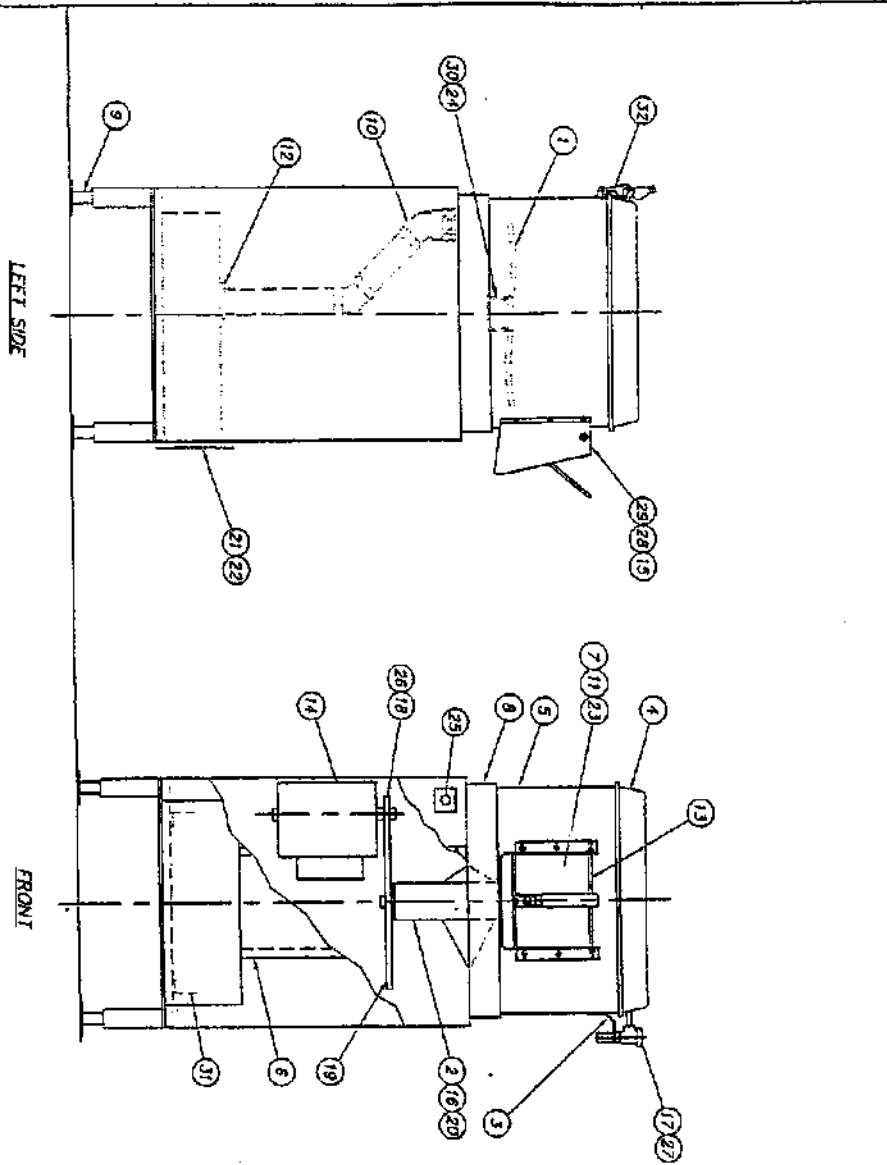

ITEM NO.	PART NO.	PART NAME	QTY.
1	974-99	ABRASIVE DISC	1
2	D2434	BEARINGS	2
3	974-20	BRACKET	1
4	974-24	CYLINDER COVER	1
5	974-68	CYLINDER	1
6	974-B8	ACCESS DOOR	1
7	974-104	CYLINDER DOOR	1
8	974-5	FEELER GASE	1
9	D2435	ADJUSTABLE FOOT	4
10	974-97	DRAIN PIPING	1
11	974-33	HANDLE CYLINDER DOOR	1
12	D3-548	GRINDERS	1
13	974-12	HINGE PIN	1
14	D2464	MOTOR 3/4 HP (30VP)	1
15	974-63	CHUTE ASSEMBLY	1
16	D2-510	OW SEAL	1
17	D22424	POPPER DISC, VACUUM BREAKER	1
18	D2436	PAWLEY 2.75 O.D.	1
19	D2437	PAWLEY 15.3 O.D.	1
20	B-100	RETAINING RING	1
21	974-91	DRAIN BOX ASSEMBLY	1
22	974-106	SCRAP DRAINER	1
23	974-29	SPACER	1
24	974-7	SPINDLE	1
25	DES-15	SHOULDER TOGGLE	1
26	D2459	1/2 BELT 4L920	1
27	D2912	VACUUM BREAKER 1/4 HP	1
28	974-64	GASKET	1
29	D312C-EF-5	SEAL NUT #10-32	8
30	974-59	SPINDLE PIN	1
31	974-86	DRAINER TRACK ANGLE	1
32	1531-21	COVER LATCH ASSY	2

* = 974-664 FOR 30 VP
 * = 974-685 FOR 50 VP
 * = D2464A - 1 HP FOR 30 VP
 (SPECIFY VOLTAGE CYCLE & PHASE)

REV	CON NO.	DATE
A	2066	2/14/06

FILE SWITCH/5K-2702

TOLERANCES
FRACTIONS 14/64
DECIMALS
XXX ± .005
XX ± .01
UNLESS OTHERWISE SPECIFIED

TITLE: 30VP & 50VP PARTS LIST
 FRONT SCRAP DRAINER

INSINGER
 PHILADELPHIA, PA 19175
 FAX (215) 824-5956

REV	CON NO.	DATE
A	2066	2/14/06

FILE SWITCH/5K-2702

TITLE: 30VP & 50VP PARTS LIST
 FRONT SCRAP DRAINER

INSINGER
 PHILADELPHIA, PA 19175
 FAX (215) 824-5956

Fig. 7-3

ITEM NO.	PART NO.	PART NAME	REQ'D.
1	974-99	ABRASIVE DISC W/HANDLE	1
2	D2434	BEARINGS	2
3	974-20	BRACKET	1
4	974-24X	CYLINDER COVER (STAIN. STEEL)	1
5	1533-23	CYLINDER (LARGE OPENING)	1
6	1533-12	ACCESS PANEL	1
7	1533-15	CYLINDER DOOR	1
8	974-6	PEELER BASE	1
9	D2978	LEVELING FOOT	2
10	974-97	DRAIN PIPING	1
11	1533-9	DOOR LATCH ASSEMBLY	1
12	D3-548	GRAMMET	1
13	1533-19	HINGE PIN	1
14	D2464A	MOTOR 1 HP (SUMP)	1
15	1533-22	EXTENDED CHUTE ASSEMBLY	1
16	D2-540	OIL SEAL	1
17	D242A	POPPET DISC, VACUUM BREAKER	1
18	D2438	PULLEY 2.75 O.D.	1
19	D2437	PULLEY 19.3 O.D.	1
20	B-100	RETAINING RING	1
21	-	-	-
22	1533-17	SCRAP DRAWER	1
23	-	-	-
24	1533-18	SPINDLE	1
25	DEI-100	SWITCH TOGGLE	1
26	D2459	"Y" BELT 4L520	1
27	D2412	VACUUM BREAKER 1/4 IPS	1
28	1533-24	GASKET (LARGE OPENING)	1
29	D3120-6F-5	SEAL NUT #10-32	8
30	974-58	SPINDLE PIN	1
31	974-86	DRAINER TRACK ANGLE	2
32	D2840	CASTER, RIGID	2
33	1533-18	TRIPPING HANDLE	2
34	1533-31	COVER LATCH ASSEMBLY	2
35	1533-11	COVER - MOTOR ACCESS SLOT	1
36	DES-72	COVER - SWITCH	1

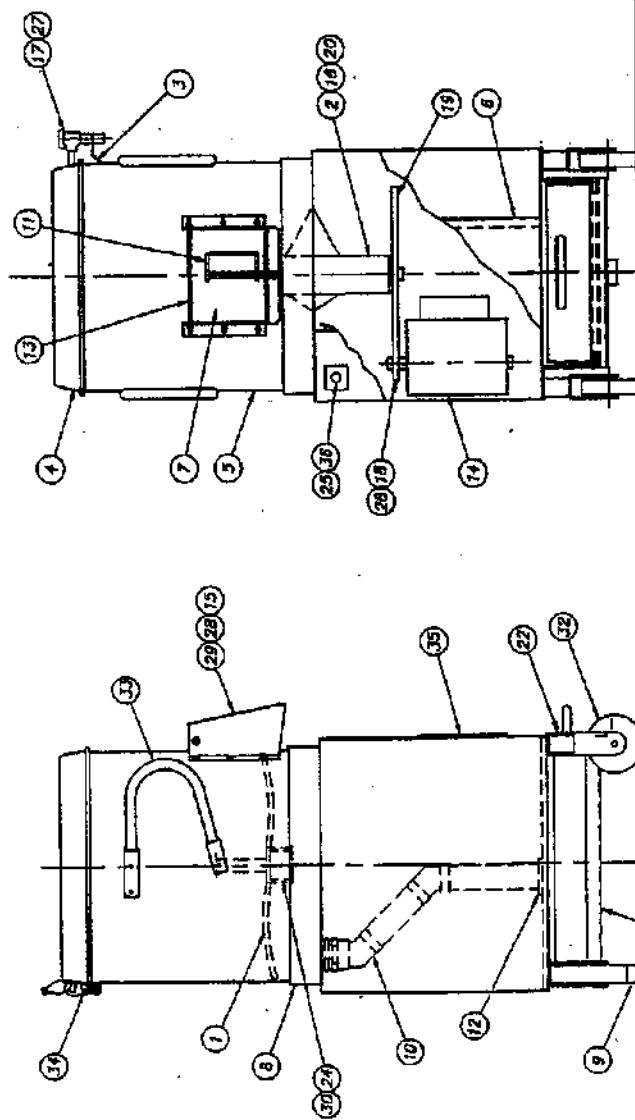

TOLERANCES		TITLE		NEXT ASSTY. NO.	
D	2030	5.005	ASSEMBLY & PARTS LIST	REQ'D.	1533-1
C	2030	4.305	NOTED	SCALE	1-10
B	2030	1.1604		USED ON	SUMP
A	2030	0.2604		DATE	07/17/74
REV. LEV. NO.	DATE	Philadelphia, PA 19138			
FILE PARTS 1533-1		(315) 824-4800			
		FAX (215) 824-8866			

** ITEM #25 REQUIRES HEATER COIL (FUSE)
DES-223M5HS-6A FOR 120V
* - REPAIR PART FOR ITEM #27

Insinger 30VP and 50VP

This page intentionally left blank

CHAPTER 8

INSTALLATION

WARNING

All portions of the installation must comply with applicable local regulations, codes, and requirements.

8.1 UNPACKING

The vegetable peeler is shipped from the factory securely bolted to a single shipping pallet.

8.1.1 Carefully remove all external protective crating.

8.1.2 Remove all fasteners holding the vegetable peeler and component parts to the pallet.

8.1.3 Check that the following items have been received:

Qty.	Description
1	Vegetable peeler.
1	Abrasive disk.
1	Optional disposer.
1	Technical manual.

8.2 INSTALLATION

8.2.1 Mechanical and piping.

8.2.1.1 The vegetable peeler is designed for floor installation. Position the unit to provide clearance and/or access to:

The front access panel.

The optional disposer.

The discharge chute (for a vegetable collection container or sink).

The optional scrap drawer.

8.2.1.2 Level the machine, using the adjustable flanged legs.

CAUTION

The four flanged legs of the vegetable peeler should be bolted to the floor. The optional front casters on selected units must be locked whenever the peeler is operated.

8.2.1.3 Connect a 1/4" cold water supply line to the vacuum breaker on the side of the hopper. A flexible hose is preferable. Install a ball valve on this line for flow control.

8.2.1.4 Connect a 2" drain line to the drain coupling on the bottom of the peel trap or bottom of the optional scrap drawer chamber. Machines with optional scrap drawers may also be located directly above a floor drain. For the optional disposer, the drain connection is the 1-1/2" slip fitting on the side of the disposer.

8.2.2 Electrical.

WARNING

All work should be done by a qualified electrician. All motor services must be grounded.

8.2.2.1 Connect the drive motor switch to a properly sized fused disconnect or circuit breaker.

8.2.2.2 Connect the optional disposer switch to a properly sized fused disconnect or circuit breaker.

NOTE

Wiring connections, including grounds, should be made inside the respective switch enclosures. Use strain relief fittings on the enclosures.

Power requirements for the drive motor and optional disposer are listed in Table 1-1.

Insinger 30VP and 50VP

8.2.3 Check-Out of the installation.

8.2.3.1 Perform the Start-up Procedure, section 3.3.

8.2.3.2 The drive motor may rotate in either direction. The optional disposer rotation is fixed by the switch to disposer wiring.

8.2.3.3 Inspect all plumbing joints for leakage and verify that water can run freely through the drain.

Fig. 8-1

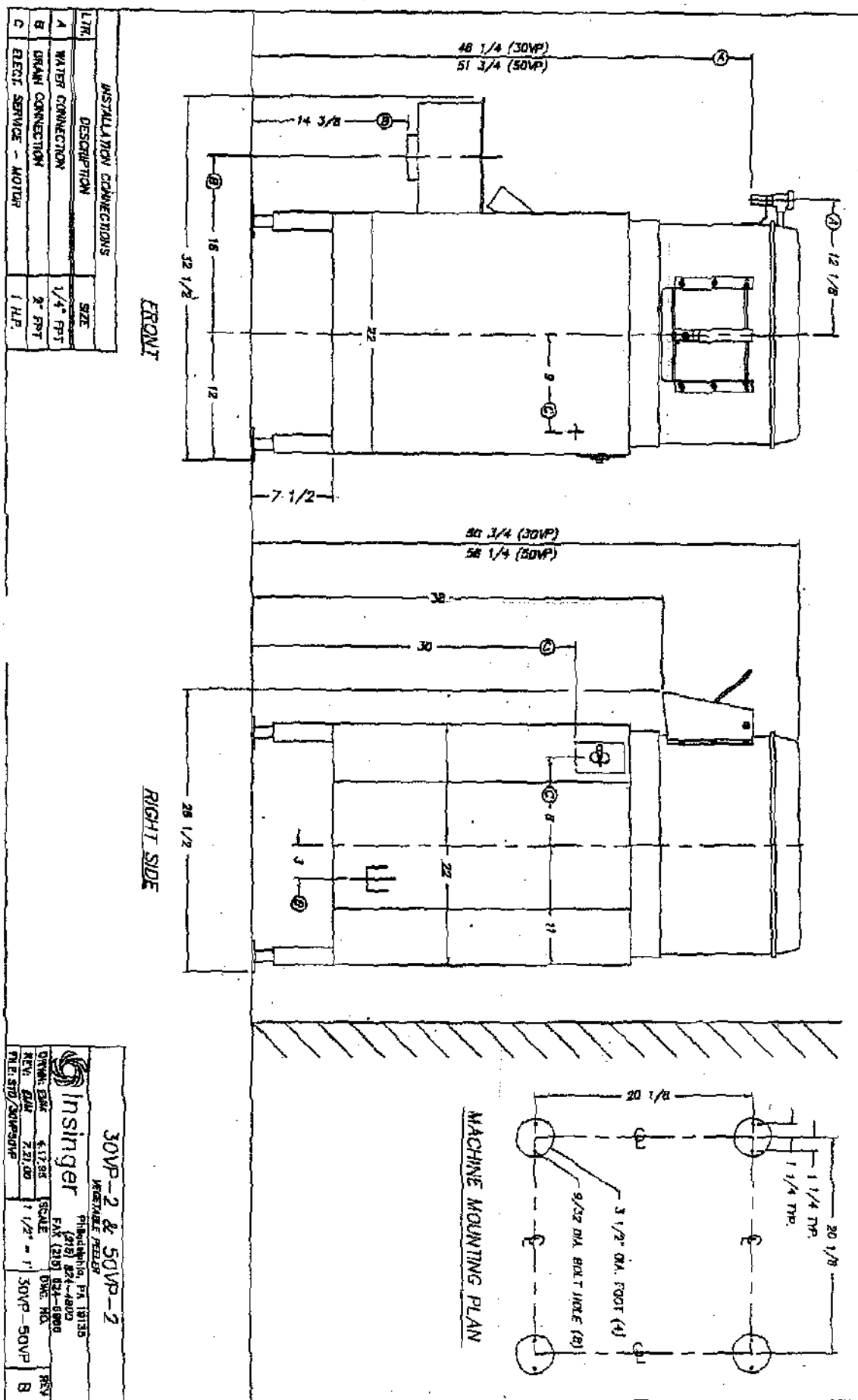

Fig. 8-2

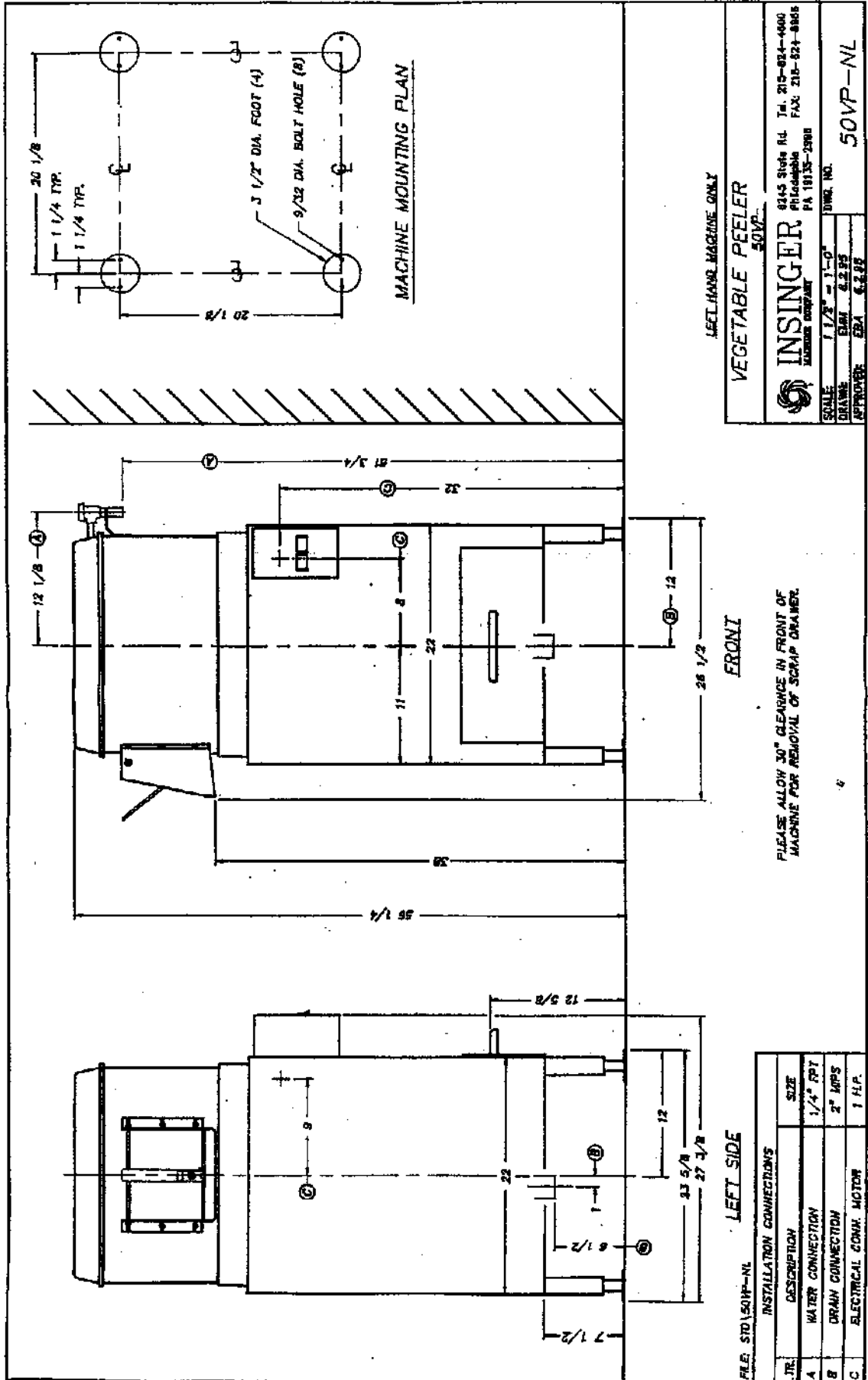
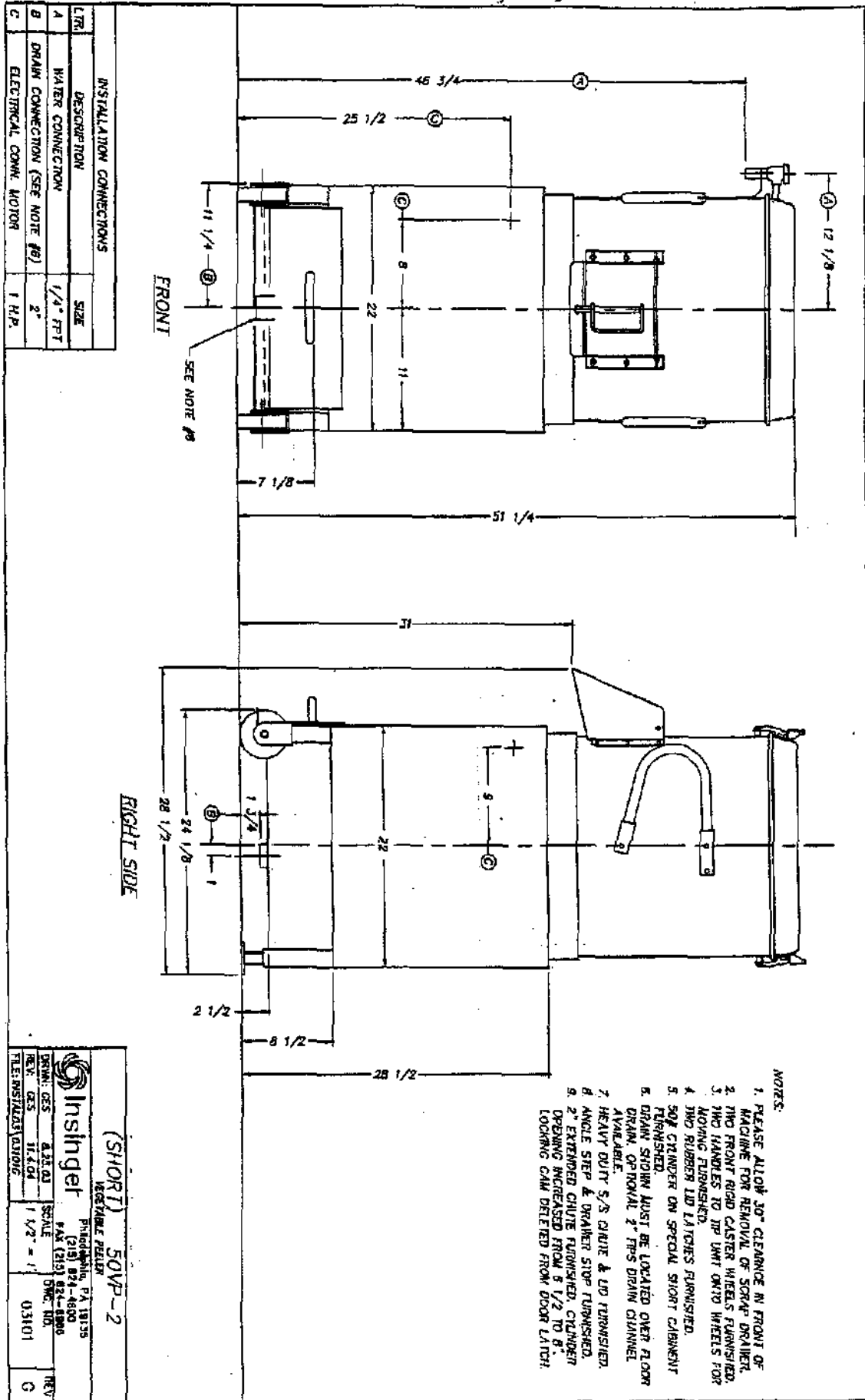
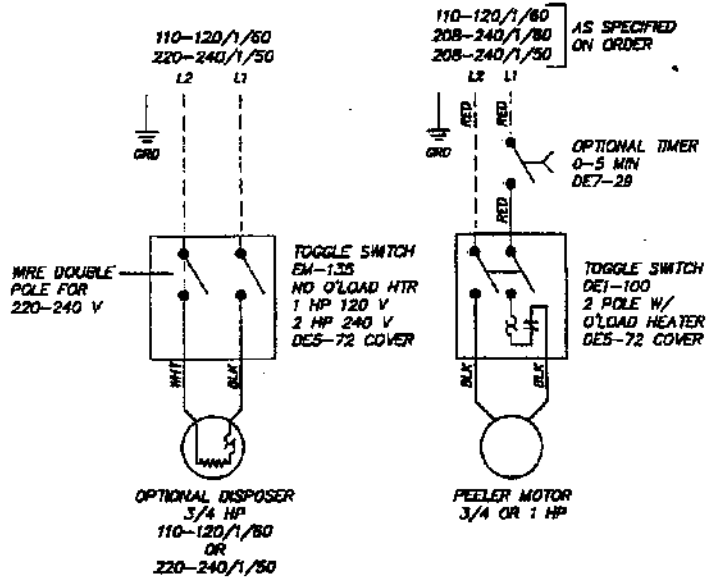

Fig. 8-3



- NOTES:
- PLEASE ALLOW 30" CLEARANCE IN FRONT OF MACHINE FOR REMOVAL OF SCRAP-DRAINER.
 - TWO FRONT RIGID CASTER WHEELS FURNISHED.
 - TWO HANDLES TO PE UNIT MOUNTED WHEELS FOR MOVING FURNISHED.
 - TWO RUBBER LID LATCHES FURNISHED.
 - 50# CYLINDER ON SPECIAL SHORT CABINET FURNISHED.
 - DRAIN STOPPIN MUST BE LOCATED OVER FLOOR DRAIN, OPTIONAL 2" FTS DRAIN CHANNEL AVAILABLE.
 - HEAVY DUTY S/S CHUTE & LID FURNISHED.
 - ANGLE STOP & DRAINER STOP FURNISHED.
 - 2" EXTENDED CHUTE FURNISHED. CYLINDER OPENING INCREASED FROM 8 1/2 TO 8". LOCKING CAM DELETED FROM DOOR LATCH.

Fig. 8-4



CONFIGURATION A
STANDARD SINGLE PHASE
OPTIONAL DISPOSER ONLY FOR
110-120/1/60
OR
220-240/1/50.

SINGLE PHASE WIRING

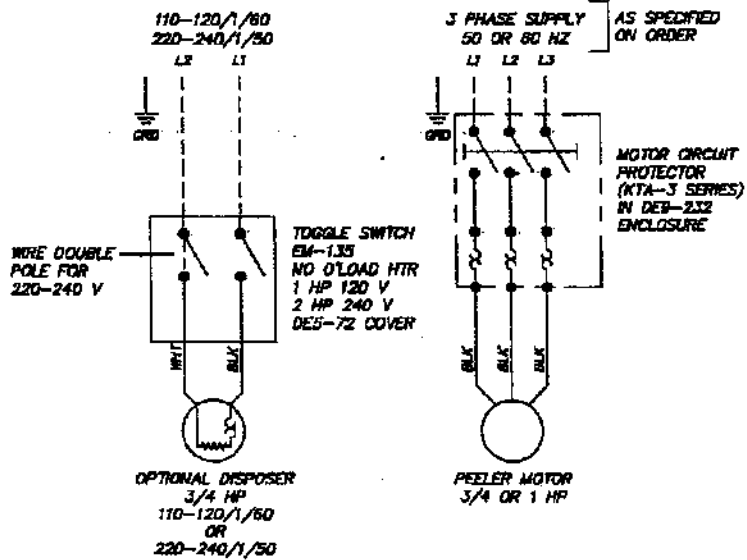

CONFIGURATION B
STANDARD THREE PHASE
OPTIONAL DISPOSER ONLY FOR
110-120/1/60
OR
220-240/1/50

THREE PHASE WIRING

E		9.1.05	TITLE	VEGETABLE PEELERS W/ OPTIONAL DISPOSERS	DWG. NO. 302
D	1590	10.8.97			
C	1078	6.18.94			
REV	ECN NO	DATE	Philadelphia, PA 19135 (215) 524-4800 FAX (215) 624-8986		DRWN/DATE
FILE:	WIRE1302				MPJ

Insinger 30VP and 50VP

This page intentionally left blank