



SW48

Technical Manual

SW48





Thank you for purchasing this quality Insinger product.

On the space provided below please record the model, serial number and start-up date of this unit:

Model: _____

Serial Number: _____

Start-Up Date: _____

When referring to this equipment please have this information available.

Each piece of equipment at Insinger is carefully tested before shipment for proper operation. If the need for service should arise please contact your local Authorized Insinger Service Company.

A Service Network Listing is provided on our web site, www.insingermachine.com or call Insinger at 800-344-4802 for your local authorized servicer.

For proper activation of the Insinger Limited Warranty a SureFire™ Start-Up & Check-Out Service should be completed on your machine. Refer to the Introduction section in this manual for an explanation of Insinger SureFire™ Start-Up & Check-Out Program.

Please read the Insinger Limited Warranty and all installation and operation instructions carefully before attempting to install or operate your new Insinger product.

To register your machine for warranty by phone, fax or the internet or for answers to question concerning installation, operation, or service contact our Technical Services Department:

TECHNICAL SERVICE CONTACTS	
Toll-Free	800-344-4802
Fax	215-624-6966
e-mail	service@insingermachine.com
Web site	www.insingermachine.com



Table of Contents

Table of Contents	3
Warranty	4
Specifications	6
Electrical Data Breakdown	7
Warnings and Cautions	8
Introduction	9
Installation Instructions	10
Start-Up Procedures	13
Sequence of Operation	15
Operation of Machine	15
Preventive Maintenance	17
Trouble Shooting –Electric Machine	19
Trouble Shooting –Gas Machine	20
Trouble Shooting –Steam Machine	20
Parts List	21
Drawings:	
General View	24
Floor Model with Ramp	25
Three View: Gas Wash Heat – Pit Model	26
Three View: Electric Wash Heat – Floor Model	27
Three View: Steam Wash Heat – Floor Model	28
Concrete Pit Specifications	29
Stainless Steel Pit Specifications	30
Stainless Steel Pit Liner – Top View	31
Stainless Steel Pit Liner – Top View	32
Bun Pan Rack	33
Cake Pan Rack	34
Bowl/Utensil Rack	35
Rinse System	36
Floor Grate and Screen Location	37
Electric Wash Heat –Control Circuit Ladder Diagram	38
Gas or Steam Wash Heat –Control Circuit Ladder Diagram	39
Trouble Shooting Flowchart	40



INSINGER MACHINE COMPANY LIMITED WARRANTY

Insinger Machine Company, Inc. (Insinger) hereby warrants to the original retail purchaser of this Insinger Machine Company, Inc. product, that if it is assembled and operated in accordance with the printed instructions accompanying it, then for a period of either 15 months from the date of shipment from Insinger or 1 year (12 months) from the date of installation or start-up that said Insinger product shall be free from defects in material and workmanship. Whichever one of the two aforesaid limited warranty time periods is the shortest shall be the applicable limited warranty coverage time period.

Insinger may require reasonable proof of your date of purchase; therefore, you should retain your copy of invoice or shipping document.

This limited warranty shall be limited to the repair or replacement of parts which prove defective under normal use and service and which on examination shall indicate, to Insinger's satisfaction, they are defective. Any part that is claimed to be defective and covered by this limited warranty must be returned to Insinger. An RMA# must be obtained from the Insinger Warranty Department before returning any material. Return may be done through an Authorized Service Agency. Furnish serial number of machine and RMA # with shipment and send to:

*Insinger Machine Company
6245 State Road
Philadelphia, PA 19135-2996*

If Insinger's inspection confirms the defect and the claim, Insinger will repair or replace such part without charge and return it to you freight or postage prepaid.

This limited warranty does not cover any failure or accident, abuse, misuse, alteration, misapplication, improper installation, fire, flood, acts of God or improper maintenance or service, or failure to perform normal and routine maintenance as set out in the instruction booklet (operating instructions) or for improper operation or failure to follow normal operating instructions (as set out in the instruction booklet). Insinger is not responsible nor liable for any conditions of erosion or corrosion caused by corrosive detergents, acids, lye or other chemicals used in the washing and or cleaning process.



Service must be done by either Insinger Appointed Service Agencies or agencies receiving prior authorization from Insinger.

All warranty work must be done during normal working hours, unless purchaser receives prior authorization from Insinger.

There are no other express warrants except as set forth herein and any applicable implied warranties of merchantability and fitness are limited in duration to the period of coverage of this express written limited warranty. This limited warranty supersedes all other express warranties, implied warranties of merchant-ability and fitness or limited warranties as of this date, January 1, 1998. Some states do not allow limitation on how long an implied warranty lasts so this limitation may not apply to you.

Insinger is not liable for any special, indirect or consequential damages. Some states do not allow the exclusion or limitation of incidental or consequential damages, so this limitation nor exclusion may not apply to you.

Insinger does not authorize any person or company to assume for it any other obligation or liability in connection with the sale, installation, use, removal, return or replacement of its equipment: and no such representations are binding on Insinger.



SW-48-RI SPECIFICATIONS

OVERALL DIMENSIONS

WIDTH = 57" (60" WITH SIDE SUPPORT ANGLES)
DEPTH = 65"
HEIGHT (OVERALL) = 92-1/2" (94-1/2" GAS)
HEIGHT (PIT MODEL) = 81-1/2" ABOVE FLOOR

HOT WATER SYSTEM

1" HOT WATER SUPPLY REQUIRED, UNION PROVIDED
140° F. WATER REQUIRED AT THE MACHINE
168 GPH AT 20 PSI (14 GAL./CYCLE x 12 CYCLES/HR.)
RINSE BOOSTER: TWO 9 kW HEATING ELEMENTS IN A 20 GAL. RINSE TANK

FULL LOAD AMPS

	208 VOLT	230 VOLT	460 VOLT
ELECTRIC	133.1	122.3	62.1
GAS/STEAM (INJECTED)	95.6	88.4	45.2
STEAM (RECIRCULATING)	45.6	43.2	22.6

GAS SYSTEM (GAS MACHINES ONLY)

1/2" GAS SUPPLY
NATURAL: 7" W.C. MINIMUM INLET, 6" W.C. MAIN MANIFOLD = 66,000 BTU
PROPANE: 11" W.C. MINIMUM INLET, 10" W.C. MAIN MANIFOLD = 66,000 BTU
4" STAINLESS STEEL CHIMNEY ON BACK OF MACHINE

STEAM SYSTEM (STEAM MODELS ONLY)

3/4" STEAM LINE, 10 to 15 PSI –
37 LBS. PER HOUR AVERAGE ELECTRIC HEATED RINSE
76 LBS. PER HOUR AVERAGE STEAM HEATED RINSE

WASH SYSTEM

10 HP & 5 HP PUMPS IN SERIES RECIRCULATES APPROXIMATELY 240 GPM @ 60 PSI

HEAT: >ELECTRIC – ONE 9 kW AND ONE 4.5 Kw HEATING ELEMENT
>GAS – THREE 22,000 BTU RATED INFRARED BURNERS = 66,000 BTU
>STEAM – DIRECT INJECTION, 10 to 15 PSI, 37 LBS. PER HOUR AVERAGE
RECIRCULATED, 10 to 15 PSI, 76 LBS. PER HOUR AVERAGE

65 GALLON WASH TANK

1-1/2" COPPER DRAIN

8" STEAM EXHAUST VENT COMPANION FLANGE

(REQUIRES PVC, CPVC, OR STAINLESS STEEL FIELD INSTALLED DUCT)



ELECTRICAL DATA for MODELS SW-48-RI Electric

3phase Voltage	208	230	460
Pump Motor	43.6	41.2	20.6
Control Circuit	2.0	2.0	2.0
Wash Heater (one 9kW + one 4.5 kW)	39.5	35.9	18.9
Rinse Heater (two 9kW)	50.0	45.2	22.6
Total Running Current	133.1	122.3	62.1
Exhaust fan (Opt.)	2.0	2.0	1.0

ELECTRICAL DATA for MODELS SW-48-RI Gas

3phase Voltage	208	230	460
Pump Motor	43.6	41.2	20.6
Control Circuit	2.0	2.0	2.0
Rinse Heater (two 9kW)	50.0	45.2	22.6
Total Running Current	95.6	88.4	45.2
Exhaust fan (Opt.)	2.0	2.0	1.0

ELECTRICAL DATA for MODELS SW-48-RI Steam

3phase Voltage	208	230	460
Pump Motor	43.6	41.2	20.6
Control Circuit	2.0	2.0	2.0
Total Running Current	45.6	43.2	22.6
Exhaust fan (Opt.)	2.0	2.0	1.0

Electrical Supply to the machine should exceed the figures by the amount required by local codes.

Note: Changing the voltage of the machine in the field requires different heating elements.

Contact the factory if this situation arises.



General Warnings and Cautions

- 1 Service work on the machine should be done by either a factory representative or qualified local service company. Contact the factory if the machine is under warranty.
- 2 Failure to follow the cleaning guidelines described in this manual will damage the machine and will void the warranty.

Gas Model Warnings and Cautions:

- 1 Installation must conform with local codes and the National Fuel Gas Code, ANSI Z223.1. In Canada: Installation must be in accordance with CGA Standard CAN/CGAB149.1, Natural Gas Installation Code or CAN/CGAB149.2, Propane Installation Code.
- 2 Instructions should also be posted in a prominent location describing what to do in the event that the smell of gas is detected in the vicinity of the machine. (This information can be obtained from your local gas supplier).
- 3 Do not obstruct the flow of ventilation and combustion air to the machine.
- 4 Gas model pan washers are equipped with an electronic ignition which automatically lights the burners when the power switch is turned to the "ON" position and there is enough water in the machine. To shut the burners off, the power switch should be turned to the "OFF" position.

FOR YOUR SAFETY: DO NOT STORE OR USE GASOLINE OR OTHER FLAMMABLE VAPORS OR LIQUIDS IN THE VICINITY OF THIS OR ANY OTHER APPLIANCE.

WARNING: IF YOU SMELL GAS, SHUT OFF THE GAS SUPPLY TO THE APPLIANCE, EXTINGUISH ANY OPEN FLAME, AND TEST ALL JOINTS WITH A SOAP SOLUTION. IF ODOR PERSISTS, CALL YOUR GAS SUPPLIER IMMEDIATELY.

AVERTISSEMENT: SI UNE ODEUR DE GAZ EST DÉCELÉE, COUPER L'ALIMENTATION EN GAZ DE L'APPAREIL, ÉTEINDRE TOUTES LES FLAMMES ET VÉRIFIER TOUS LES RACCORDS À L'AIDE D'UNE SOLUTION SAVONNEUSE. SI L'ODEUR PERSISTE, AVERTIR IMMÉDIATEMENT LE FOURNISSEUR DE GAZ.



Introduction

This manual should be read and understood by everyone involved with the installation and operation of the pan washer. Keep this manual in a safe place for future reference. Extra copies or replacement copies can be purchased from the manufacturer.

Service work on the machine should be done by either a factory representative or qualified local service company. Contact the factory if the machine is under warranty.

The INSINGER pan washer is designed for use in bakeries, restaurants, schools, hospitals, and hotels, to clean pots, pans, bowls, and utensils. INSINGER pan washers are constructed of 14 gauge stainless steel (cabinets) and 12 gauge stainless steel (framework). The interior piping, rinse system, wash arms, and screens are stainless steel. The control panel is assembled with UL approved components and is housed in a stainless steel control box. Because of its sturdy construction, it will deliver years of powerful, thorough cleaning.

The machine is equipped with a heating element in the rinse tank to boost the rinse water to a sanitizing 180° F at the inlet to the machine. A rinse tank heated with recirculating steam is an option available on some models.

The wash tank on electric models incorporates a 9 kW heating element for heating the wash water. The gas models use a series of (3)22,000 BTU infrared burners. Steam models use a direct injection system or a recirculating steam heating coil.

The pump recirculates wash water at approximately 55 pounds per square inch of pressure.

Each machine is equipped with two safety switches. The first is a low water cutoff, which shuts the machine off when the water level in the wash tank falls below the required level. The other safety device is a door switch, which prevents the machine from operating when the door is not completely closed. An electrical schematic for your machine is posted inside the control box cover.

Detergent Feeders

This machine must be operated with an automatic detergent feeder, including a visual means to verify that detergent is delivered or a visual or audible alarm to signal that detergent is not available for delivery. Power for the feeder can be provided by the pump supply connection in the control panel. See feeder equipment manual for additional information.



Installation Instructions

Step 1 READ: Read and understand these instructions thoroughly before attempting any part of the installation procedure.

WARNING: Not following these instructions may void warranty, cause damage to the equipment and/or cause injury to anyone involved in the installation or operation of this machine.

A copy of the installation instructions and startup procedure is printed on the yellow sheet attached to the side of the machine. EVERYONE involved with the installation must be familiar with all aspects of the installation procedure.

Step 2 POSITIONING: The factory recommends leaving as much room as possible around the machine for future service work. No less than 16" should be allowed along the sides of the machine (36" for side with control box) and no less than 12" between the rear of the machine and the wall. Extra room around the machine will facilitate cleaning the washer area.

Note: Gas models should be installed in a location free of drafts.

Step 3 UNCRATING: Leave the machine fully crated until the washer is placed in the location where it is to be installed. Inside you will find the accessories for the machine. Among these will be the fan and the legs (if ordered). The legs are adjustable by turning the small end one way or the other. Legs are not required for pit models.

When a pit is used it can be installed prior to receiving the machine. There are two types of pits to choose from: concrete (see page 29) or stainless steel (see pages 30 – 32). Concrete pits are the most common. They are usually installed by a general contractor. Note that the drain system will also be installed at this time. Generally concrete pits are painted to make them waterproof.

A stainless steel pit is available for installation in buildings with basements. The stainless pit can also be used as a liner with concrete poured around it. The stainless steel pit is equipped with a coupler to allow the plumber to connect the drain (see pages 30 – 32).

Prior to receiving the rack washer, the service lines can be stubbed in close to where the rack washer will be installed (see page 24). This will speed up the completion of the installation once the machine is in place.

There are many methods for setting the machine in the pit. Often the machine is slid into the pit from the front. Hydraulic jacks, pry bars and pallet jacks or forklift are usually necessary to accomplish the task. Keep in mind that the heaviest part of the machine is the backside where the pumps are located.

Once the machine is in the pit, the front floor grate should be set in place. The machine should then be moved ahead to eliminate any gaps between the machine and the floor grate, yet leaving enough a space that the floor grate can be removed for periodic hosing down of the pit floor.



Step 4 DRAIN: Provisions for the drain should be made next. The rack washer has a copper drain located as shown on pages 26 - 28 of this manual (see page 6 for drain size). The drain should be plumbed according to local code. Local ordinance may require a grease trap, vent, and/or a floor sink. If required, these should be installed before the machine is installed. It is strongly recommended that unions be used to allow the machine to be easily moved. Failure to do so may void the warranty.

Models that set in a pit do not require a drain connection because the wash tank drains directly into the pit.

Step 5 WATER SUPPLY HOOKUP: The factory recommends 140° F (120° F minimum) hot water at the machine (see page 3 for water line size). This may require a dedicated water heater for the pan washer. If hard water is present, the manufacturer recommends installing a water softener or calcium filter. Hard water deposits will shorten the life of many of the components on the pan washer, resulting in higher maintenance costs. Please note that a union is installed at the point of hookup (see pages 26 - 28). This will allow the machine to be moved for service and cleaning. The customer must furnish a shutoff valve on the supply side of the union. This shutoff should be easily accessible to the operator of the machine.

Step 6 STEAM VENT: The machine is equipped with a collar for 8" duct work as shown on pages 26 - 28. This duct should be directly vented to the outside of the building. DO NOT vent into a wall, attic, or any other concealed space of the building, and avoid horizontal runs of duct.

The factory recommends 8" plastic pipe or stainless steel duct for the vent. If stainless steel is used, the duct work should be installed with reverse joints so that the condensate inside the vent can drain back into the machine without leaking. All seams should also be sealed with silicone sealant.

Generally, the machine is ordered with the fan option; a 700 cfm, ½ hp squirrel cage fan (¾ hp on 50 Hz machines). The 700 cfm fan and adapter (provided) should be mounted and siliconed directly to a flange on the top of the machine before the ductwork is installed. The ductwork attaches directly to the exhaust of the fan. Wire is provided to wire the fan directly into the control panel. A dedicated breaker and contactor for the 700 cfm fan are provided. The 700 cfm fan is controlled by a timer and runs for a short time at the end of each cycle.

Note: Consult the factory before connecting any fan not supplied with the machine

Step 7 ELECTRICAL CONNECTION: The electrical connection to the machine should be made by a qualified electrician. All steps should be taken to insure that the supply voltage to the machine is the same as the rated voltage of the machine. Also check that sufficient amperage is supplied to the machine (see page 6 or page 7 for ratings).

A main power shutoff, supplied by the customer, must be installed near the machine in a place easily



accessible by anyone operating or servicing the machine. The line from the main shutoff to the machine should be watertight flex conduit. The factory strongly recommends that a few extra feet be used to allow the machine to be moved if necessary. The wire used to supply the machine must be heavy enough to carry the amperage load of the machine.

The first connection should be the main ground to the grounding lug at the lower right hand corner of the control panel. Next the hookup can be made to the main power block. On 230 VAC machines the wild leg must be connected to the center terminal.

Once the hookup is complete the circuit breakers in the control box of the washer must be checked to make sure they are in the "OFF" position. The main switch on the wall can then be turned on to power the machine.

Step 8 GAS CONNECTION (Gas models only): A certified gas technician is required for the hookup and final adjustments of the burners. This is necessary to insure proper inlet and manifold pressure for the gas machines (see page 6 for gas pressure settings).

Verify the type of gas supply to be used, either natural or LP, and make sure the marking on the gas data plate agrees with that of the supply. The gas line hookup must be made with a union at the location shown on page 26 (see page 6 for gas line size). This line must have a shutoff valve (supplied by the customer) installed near the machine and accessible by anyone operating or servicing the machine.

A stainless steel gas chimney runs up the backside of the machine (see page 6 for size of chimney). A draft diverter is included with the machine (shipped inside the machine with the other accessories). The draft diverter must be installed on top of the factory installed chimney. The Type B gas flue can then be continued to the outside of the building per local codes.

The initial startup of the burners should not be done until the startup procedures for the machine on the following pages have been completed.

Step 9 STEAM HOOKUP (Steam models only): A steam line is required to supply the steam injector or recirculated steam heat exchanger coil (see page 6 for size of steam line). A strainer is already built into the machine but a union will be required in the supply line (supplied by the customer). The Specification sheet on page 6 lists the rated pressure and average steam consumption rate for the machine.



StartUp Procedures

Warning: These instructions must be followed or damage to the machine will result.

Step 1: Close the drain valve (see location on pages 26 - 28). On machines equipped with Auto Fill and Auto Drain, the drain valve will automatically close when the Auto Fill button is pushed.

Step 2: Open the main water supply valve (if the machine is equipped with the Auto Fill option, skip to Step 3), then open the fill valve (see location on pages 26 - 28). Fill the machine to the level of the scrap trays. The machine is equipped with a low water protection device and will not run without sufficient water in the wash tank.

Step 3: With the circuit breakers in the control panel of the machine in the "OFF" position and the main power supply to the machine connected, the ON-OFF switch on the button panel can be turned to the "ON" position. This should light the amber power light. If not, check this bulb and the other two bulbs to make certain they are tight.

Machines equipped with the Auto Fill option can now be filled by pressing the Auto Fill button. (If the building supply pressure is quite high, some water may run out the overflow at the end of the fill cycle.)

Note: The machine has a door safety switch and will not operate with the door partially open.

Step 4: With the machine full of water and with the door closed, press the start button and let the machine go through a complete cycle. The timers in the control panel will go through their sequence, lighting the wash and rinse lights on the front of the machine. The cycle is complete when the clear and red light go off and the amber light stays on. The pump will not run at this time because the pump circuit breaker in the control panel is in the "OFF" position.

Step 5: Repeat Step 4 one more time or until water can be heard spraying out of the rinse nozzles. This ensures that the rinse tank is full of water before the heating element is energized.

Step 6: All circuit breakers in the control panel can now be switched to the "ON" position. This will energize the heating system in the wash and rinse tanks.

Step 7: Check the pump for proper rotation by pressing the start button and observing the wash pressure gauge on the front of the machine for 5 to 10 seconds. Then press the stop button. The wash pressure should be 45- 60 psi. If the pressure is erratic and only rises to about 25 psi, the pump is running backwards. The pump will also have a noticeable growl when running backwards. The outside two wires that feed the power block in the control panel should be reversed. Run the pump again to confirm that it is operating correctly.



Step 8: With the power on, the wash and rinse heating systems should be checked. The rinse tank should take 5 to 10 minutes to reach 195° F and the wash should take approximately 40 to 45 minutes to reach 150° F. The times will vary depending on the temperature of the incoming water. Note: The rinse manifold gauge measures the temperature of the rinse water just before it enters the machine. Therefore this temperature reading is only accurate while the machine is rinsing.

If the machine is not reaching temperature, check to make sure that all the breakers in the control panel are in the "ON" position. If the wash tank is gas heated make certain that main gas valve and the gas valve in the control panel are open. During initial startup, gas machines may have to be turned on and off several times to bleed the air out of the gas lines. Wait about a minute after turning the machine off before turning it back on. If the machine still does not appear to be heating up properly, call INSINGER Manufacturing.

Step 9: Adjust the pressure regulator (see location on pages 26 - 28). The pressure should be set at 20 psi on the rinse gauge while the machine is rinsing. Variations in building water pressure may require the pressure to be increased or decreased from its factory setting.

Step 10: If the machine is equipped with the 700 cfm fan option (see page 11 for a description of the fan options) check to make sure that it is rotating in the correct direction. If the fan is blowing into the machine rather than out the vent the two outside wires on the three phase fan connection in the control panel need to be swapped. Recheck to confirm proper rotation.

Step 11: Replace all covers and peel off the plastic protective coating and tape etc. from the machine which may have been used to prepare the machine for shipping.



Sequence of Operation

Power switch "ON".

LOGO logic control is energized.

Fill button (optional) energizes fill solenoid.

Low water safety switch closes terminals 1 and 4 in the control panel if there is sufficient water in the wash tank.

Amber indicator light comes on.

Wash and rinse temp controls are energized.

Temp controls energize wash and rinse heating systems.

Door safety switch is energized.

Stop and Start buttons are energized.

Start button is pushed energizing the internal timing functions of the logic control.

Red indicator light is energized

Wash timer (Light, Medium, or Heavy) starts, energizing the pump contactor for set amount of time.

Wash time runs out energizing the rest timer.

After set amount of rest time, the rinse timer starts, energizing the rinse solenoid valve and clear indicator light.

If the machine is equipped with the exhaust fan option, the fan timer runs for the set time when the rinse times out.

After the rinse timer (or optional fan timer) has timed out, all timers are reset, and the red/clear indicator lights are de-energized.

Operation of the Machine

Initial Daily StartUp

1. Check if the inside of the machine has been properly cleaned since its last use. If not, clean the machine (refer to Final CleanUp on the following page for cleaning information).
2. Make sure scrap tray screens and the pump inlet screen are in place (see page 37).
 - a. **WARNING:** Do not operate washer without all screens in place.
3. Close the drain valve.
4. Open fill valve and fill wash tank to the top of the scrap trays or until water begins to run out of the overflow. If the machine is equipped with the Auto Fill option push the Auto Fill button to fill the unit.
5. Turn power "ON" and allow wash and rinse temperatures to come up to recommended levels.
6. While machine is warming up, the first load can be prepared and placed in the machine. If the pans are excessively dirty, they should be presoaked and scraped before being placed in the rack. Pan preparation will reduce the need to change the wash water and will speed up the entire washing process. The correct manner for loading the racks is illustrated on pages 33 - 35.
7. Once the machine has reached the recommended temperatures, detergent should be added to the wash water. Detergent should be used according to the recommendations of the chemical supplier. A non-



suds detergent is necessary and local water conditions should be considered when selecting the concentration of the detergent. An automatic soap dispenser should be installed at the job site by the chemical supplier. There should be a visible or audible means of determining detergent delivery. If they have any questions concerning the installation of their dispenser to the INSINGER pan washer, they can call the factory for advice.

8. The rack of pans can now be placed in the machine. The rack should be centered in the machine to subject the pans to the full force of the spray arms.

WARNING: Loose items and glassware should not be put in the washer. The high pressure wash cycle will damage them and potentially the machine.

Bowls or buckets can be washed by placing them upside down on the main support rack with the hold down rack installed above them in the lowest possible position.

The utensil basket is to be used to contain smaller items such as paddles, whisks, scrapers, etc. The utensil basket can be placed on top of the hold down rack and washed along with a load of pans or buckets. The utensil basket may need to be held in place by the hold down rack to prevent it from moving in the machine.

CAUTION: When loading the machine make sure that nothing will obstruct the path of the wash arms. This will avoid damage to the machine and to the items being washed.

When loading bowls, pans, or buckets into the machine make sure they are loaded in a manner that will allow the wash water to drain out of them.

9. The machine cycle is completely automatic with adjustable wash, rest, and rinse timers. The timers are located in the control panel and are factory set to the following recommended values:

Wash Light	3 min
Medium	5 min
Heavy	7 min
Rest	20 sec
Rinse	60 sec
Fan (optional)	30 sec

Select the length of wash (Light/Medium/High) with the 3 position selector on the button panel and push the green start button to initiate the wash cycle. The red indicator light will come on. At the end of the wash cycle the red light will stay on and the 20 sec rest will begin. The rest period allows the wash water and suds to drain from the pans. After the rest cycle, the rinse cycle begins. During the rinse cycle, the clear indicator light will come on. If the machine is equipped with a fan timer (see page 11 for a description of the fan options) the fan will start after the rinse is finished. After the rinse or fan cycle is finished the red and clear lights will go off. The cycle is now complete. The amber power light will stay on as long as the power switch is in the "ON" position and there is enough water in the machine.

10. Throughout the day as the machine is being used, the scrap tray screens (see page 37 for location of screens) should be periodically removed from the machine, dumped out, washed out in the sink and replaced in the machine.



Final CleanUp

1. At the end of each day's use, the operator of the machine must clean the machine according to the following procedure:
2. Check and clean any plugged wash nozzles. If necessary, the wash arm assembly can be removed by pulling out the grip ring pin and sliding the assembly out of the hub and rinsed with a spray gun.
3. Drain the machine.
4. Remove the floor grate(s) and scrap trays (see page 37 for location), dump them out and wash them off in the sink.
5. Spray down the inside of the machine.
6. Brush off the heating element (electric models) and any place that doesn't come clean from spraying with the hose. **NOTE:** (Electric Models) Brushing the element clean is very important in prolonging the life of the element.
7. Check and clean the rinse nozzles with a piece of wire to keep them from plugging up with lime and scale.
8. Spray down the inside of the machine again.
9. Remove the pump inlet screen (see page 37 for location of screen) and clean it thoroughly in the sink. **NOTE:** While removing the screen be careful not to allow any debris to fall into the pump inlet opening.
10. Replace the pump inlet screen and the scrap tray screens.
11. Close the drain and leave the machine empty of water until it is to be used again.
12. (For Pit models Only) Remove front floor grate(s) and spray pit floor from front toward rear. Clean pit drain thoroughly. Water back-up from a clogged drain will cause major burner damage! **DO NOT** allow overspray on the burner when cleaning. Burner firing problems will result. When cleaning is completed, replace the floor grate(s).

PREVENTIVE MAINTENANCE FOR INSINGER PAN WASHERS

1. Turn off power and drain machine, making sure it drains freely.
2. Check machine for general cleanliness. Make sure the pump screen and scrap trays are clean and properly in place. Wash heating elements (electric models only) must be cleaned on a daily basis for proper operation. Check for plugged wash and rinse nozzles. Check if all cleanout plugs are in place at the ends of the rotating wash arms and make sure they are not cracked or broken. If necessary, the entire wash arm assembly can be removed by pulling out the grip ring pin and sliding the assembly out of the hub. These items are part of the daily maintenance schedule and should be done on a daily basis.
3. Check for excessive play in the hub/wash arm assemblies. Excessive wear can affect the wash pressure and shorten the life of some hub components. Basic and complete hub repair kits are available from the factory.
4. Close drain valve and fill machine, making sure drain does not leak (some water may initially run out the drain through the overflow). Run through a Light, Medium, and Heavy wash cycle, checking for proper timer operation. Machines prior to 1997 may have a single adjustable wash timer in place of the three position selector.
5. Check if Power "ON", Wash, and Rinse lights are working.
6. Check if pump pressure during wash cycle is within recommended range (See owners manual or legend on gauge panel).



7. Check if rinse pressure is approximately 20 psi. Note: This must be checked during rinse cycle only for accurate reading.
8. Make sure steam exhaust fan is working properly. On machines with a 100cfm Tjernlund fan, the fan should run continuously when power switch is turned on. On machines with a 700 cfm American fan, the fan should run for set amount of time after the rinse cycle.
9. * Allow machine to heat up to recommended temperatures, noting if temp gauges and thermostats are operating properly (see start up procedure in owners manual for approximate heat up times). Wash temperature and Rinse Tank temperature should be noted at this time. The rinse water temperature gauge is accurate only during rinse cycle and should be checked while machine is rinsing.
10. Note: If a qualified technician is available, current readings for heating elements should be taken to ensure they are heating properly.
11. On machines with slideup doors, door cables and connections should be inspected for damage or excessive wear and replaced if necessary. Make sure cable pulleys turn freely and door switch is still adjusted properly.
12. Pump motor(s) should be greased occasionally depending on usage. Once or twice yearly should be sufficient under normal use.

Note:

Items above marked * are easily identified visually and should be checked on a daily basis. Other items should be checked periodically, depending on usage.

Time required for complete inspection may vary, depending on wash timer settings, heat up time, etc. One to two hours is a reasonable amount of time unless problems are encountered that need attention. If any problems or questions arise, call the factory for assistance.



Trouble Shooting Electric Machines Problem Cause Cure

Machine won't run	No power to machine Not enough water Door open	Check building power supply Fill machine until overflowing Close door tightly
Wash pressure too high	Nozzles plugged	Remove debris from nozzles
Wash pressure too low	Pump running backward Pump screen clogged Excessive suds Missing wash nozzles Missing wash arm end plugs	See installation instructions See cleaning instructions Change soap or use less Replace nozzles or wash arm Replace wash arm end plugs
Wash temperature too low	Thermostat set too low Wash element blown	Adjust wash thermostat* Replace wash heating element
Rinse temperature too low	Thermostat set too low Water supply too cold Rinse element blown	Adjust rinse thermostat* Set building hot water to 140° F Replace rinse heating element
No rinse water	Nozzles plugged Solenoid valve stuck Rinse strainer clogged	See cleaning instructions Clean solenoid valve or replace Clean pressure regulator/strainer
Rinse does not shut off	Rinse solenoid stuck open Faulty rinse timer **	Clean or replace solenoid valve Replace rinse timer
Utensils not clean	Wash time too short Water too hard Wash temperature too low Detergent problem Improper stacking of utensils	Use a longer wash Install softener Adjust thermostat* Consult chemical supplier See racking instructions

** On machines equipped with logic control, timer and relay functions are performed internally.

* Wash and rinse temp controls are located on the gauge panel on the front/side of machine.



WARNING Do not set rinse thermostat above the boiling point of water. The boiling point of water decreases with increased elevation at approximately 2° F per 1000 ft of elevation.

Trouble Shooting Gas Machines

(Same as electric model except for the following)

Low wash temperature

1. Check thermostat setting.*
2. Check switches, fuses, and breakers that control the burners.
3. Check to be sure electrical power and gas supply have not been interrupted to the burners.
4. Check that all shutoff valves in the gas line and main gas valve are in the "OPEN" position.
5. Reset ignition control and try again. To reset control:
 - a. Turn onoff selector switch to the "OFF" position.
 - b. Wait one minute, turn power switch "ON".
6. If above steps do not light the main burner, call your local gas appliance service technician. Provide the person working on the machine with the ignition system information included with this owner's manual.

WARNING: Do not attempt to light the burner manually.

Trouble Shooting Steam Machines

(Same as electric model except for the following)

Low wash temperature

- 1 Check thermostat setting.*
- 2 Check boiler pressure.
- 3 Check to be sure electric signal is being sent to the steam solenoid.
- 4 Verify that strainer in steam line is open.
- 5 Check steam solenoid.

* Wash and rinse temp controls are located on the gauge panel on the front/side of machine.

WARNING Do not set rinse thermostat above the boiling point of water.
The boiling point of water decreases with increased elevation at approximately 2 F per 1000 ft of elevation.



Pan Washer Replacement Parts List

SW-48-RI

HEATING PARTS

PART NUMBER

DESCRIPTION

509-5004	WASH & RINSE ELEMENT, 9KW 208 VOLT
509-5005	WASH & RINSE ELEMENT, 9KW 240 VOLT
509-5006	WASH & RINSE ELEMENT, 9KW 480 VOLT
509-5132	HIGH LIMIT THERMOSTAT
509-5016	INFRARED BURNER
509-5019	IMMERSION WELL
509-5026	NWH 1/2" STEAM INJECTOR (INJ. STEAM MODEL)
510-5164	1/2" STEAM SOLENOID 24V (STEAM MODEL)
509-5050	DIRECT SPARK IGNITION GAS VALVE
509-5051	DIRECT SPARK IGNITION CONTROL MODULE
509-5052	SPARK IGNITOR
509-5053	FLAME SENSOR
509-5064	IGNITION CABLE, 8'6"
509-5094	5"-7" GAS REGULATOR CONVERSION KIT
509-5097	7"-11" GAS REGULATOR CONVERSION KIT
511-5127	SENSOR WIRE
509-5099	LP GAS ORIFICE (#54)
509-5100	NAT. GAS ORIFICE (#45)

WASH SYSTEM PARTS

PART NUMBER

DESCRIPTION

103-2025	HUB ASSEMBLY
103-2048	BASIC HUB REPAIR KIT
103-2049	COMPLETE HUB REPAIR KIT
519-5038	GRIP RING PIN FOR HUB
503-5019	3/4" THREADED PIPE PLUG
510-5089	5 HP BERKELEY PUMP & MOTOR 208-230/460 VOLT
510-5090	10 HP BERKELEY PUMP & MOTOR 208-230/460 VOLT
510 5100	PUMP IMPELLER - 10 HP
510-5096	BERKELEY PUMP SEAL KIT 5 & 10 HP
510-5092	BRASS SLEEVE
510-5095	GASKET FOR EXT. BRACKET 5 & 10 HP
130-2010	WASH ARM ASSEMBLY



GAUGE PARTS

PART NUMBER	DESCRIPTION
509-5153	TEMP CONTROL – DIXELL
509-5151	TEMP CONTROL NTC SENSOR –15’ LEAD
509-5133	TEMP DISPLAY –RINSE MANIFOLD
509-5134	TEMP DISPLAY NT SENSOR –10’ LEAD
509-5060	PRESSURE GAUGE –WEISS 2-1/2”
509-5061	WEISS LENS –2-1/2”
509-5096	GAUGE SNUBBER

RINSE AND FILL SYSTEMS PARTS

PART NUMBER	DESCRIPTION
510-5011	RINSE NOZZLE, 1/4" GG10
510-5138	1" SOLENOID VALVE 24V
510-5026	1" PARKER SOLENOID VALVE REPAIR KIT
510-5050	1" PRESSURE REGULATOR
510-5052	1" VACUUM BREAKER
510-5067	1" VACUUM BREAKER REPAIR KIT
510-5053	1" BALL VALVE
514-5057	3/8" X 12' SPRAY HOSE
519-5043	BRASS SWIVEL
519-5027	SPRAY GUN

MISCELLANEOUS PARTS

PART NUMBER	DESCRIPTION
510-5145	1-1/2" NPT BALL VALVE
517-5011	4" CASTERS FOR RACKS
517-5015	DOOR LATCH
517-5018	DOOR LATCH STRIKE
517-5020	INSIDE DOOR HANDLE RELEASE
517-5024	DOOR HINGE
517-5025	LATCH –KASON
517-5026	STRIKE – KASON



ELECTRICAL PARTS

PART NUMBER	DESCRIPTION
511-5257	LOW WATER CUT-OFF FLOAT
511-5258	HIGH WATER CUT-OFF FLOAT
511-5001	ON-OFF SELECTOR
511-5077	3-POSITION SELECTOR (WASH)
511-5190	LED BULB -AMBER (PUSH-IN & TWIST)
511-5239	LED BULB -CLEAR (PUSH-IN & TWIST)
511-5240	LED BULB -RED (PUSH-IN & TWIST)
511-5214	INDICATOR LIGHT 24V -CLEAR
511-5215	INDICATOR LIGHT 24V -AMBER
511-5216	INDICATOR LIGHT 24V -RED
511-5003	AMBER LENSE (POWER "ON" LIGHT)
511-5008	RED LENSE (WASH CYCLE LIGHT)
511-5049	CLEAR LENSE (RINSE CYCLE LIGHT)
511-5007	PUSH BUTTON, GREEN CAP
511-5005	PUSH BUTTON, RED CAP
511-5004	CONTACT BOARD, N.O. (ON-OFF, WASH & START)
511-5006	CONTACT BOARD, N.C. (STOP & WASH)
511-5122	CLEAR BUTTON COVER
511-5212	LOGO CONTROL 24V
511-5213	LOGO EXPANSION MODULE 24V
511-5139	TIMER -SOLID STATE MULTI-FUNCTION
511-5179	RELAY 24V, OPDT
511-5149	CIRCUIT BREAKER, 10 AMP, 1-POLE
511-5150	CIRCUIT BREAKER, 10 AMP, 3-POLE
511-5151	CIRCUIT BREAKER, 20 AMP, 3-POLE
511-5153	CIRCUIT BREAKER, 40 AMP, 3-POLE
511-5220	HEATER CONTACTOR 24V (CGC22)
511-5222	PUMP CONTACTOR 24V, 208/230V 10HP
511-5220	PUMP CONTACTOR 24V, 460V 10HP, 208/230/460V 5HP
511-5234	PUMP OVERLOAD, 208/230V 10HP
511-5232	PUMP OVERLOAD, 460V 10HP, 208/230V 5HP
511-5230	PUMP OVERLOAD, 460V 5HP
511-5219	FAN CONTACTOR 24V, 208/230/460V
511-5228	FAN OVERLOAD, 208/230V
511-5226	FAN OVERLOAD, 460V
511-5056	.250 KVA TRANSFORMER (CONTROL CIRCUIT)
511-5253	LIMIT SWITCH
511-5045	FUSE, 2 AMP, 500 V
511-5130	FUSE, 3 AMP, 250 V
511-5181	FUSE, 12 AMP, 250 V

NOTE
 FAN CAN BE ROTATED
 360 DEGREES FOR DESIRED
 DIRECTION OF DISCHARGE

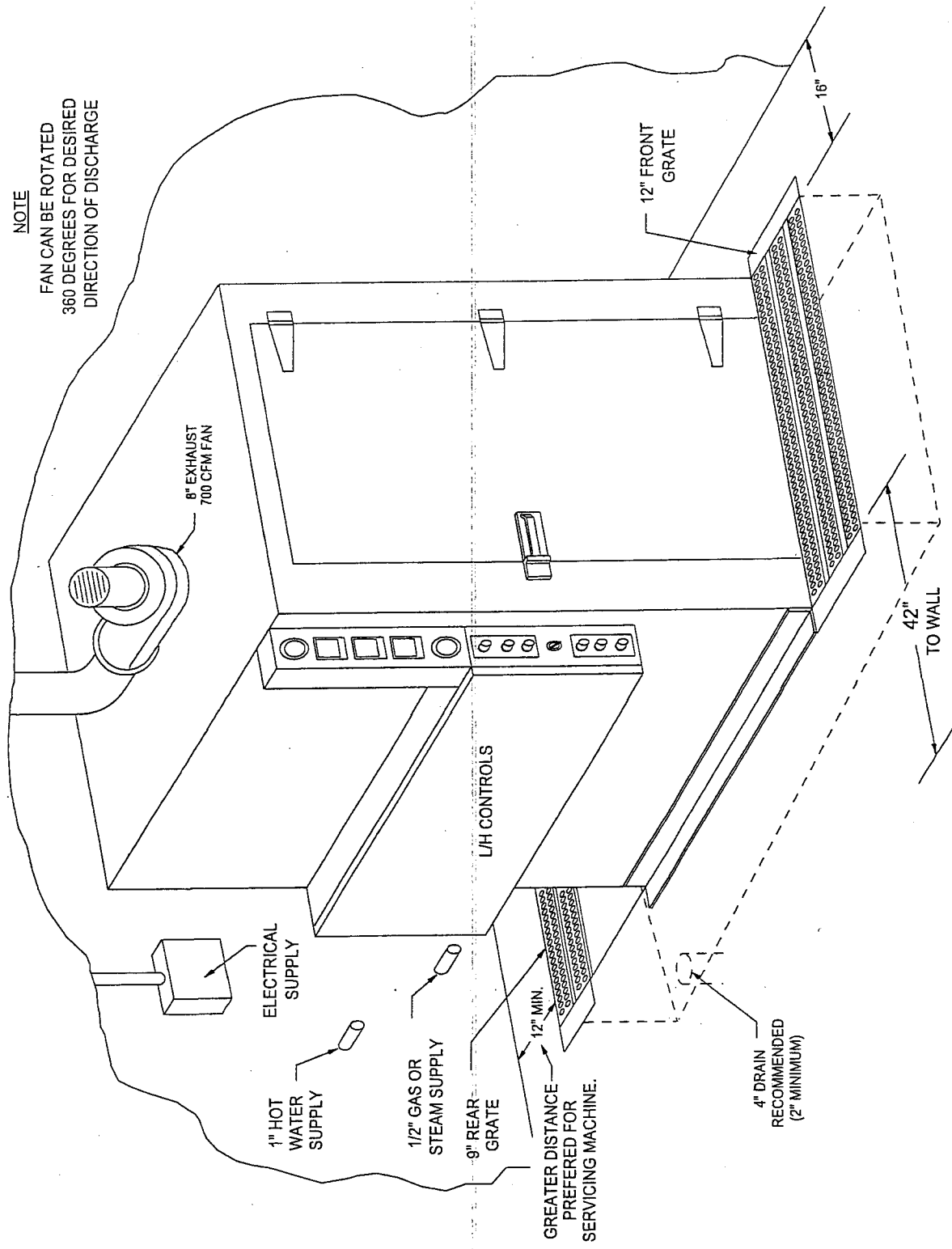

ALLOWS FOR 36" BETWEEN CONTROL BOX AND WALL.
 IF OTHER DIMENSION IS DESIRED, CHECK LOCAL
 CODES FOR DISTANCE REQUIREMENTS.

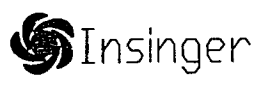

Philadelphia, PA 19135
 PHONE (215) 624-4800
 FAX (215) 624-6966

MAT.		GA.	NAME
		02-20-97	RACK WASHER
SCALE	TOL.+	M. Ebers	NO.
			130-1111
			INSTALLATION ILLUSTRATION

NOTE

FAN CAN BE ROTATED
360 DEGREES FOR DESIRED
DIRECTION OF DISCHARGE

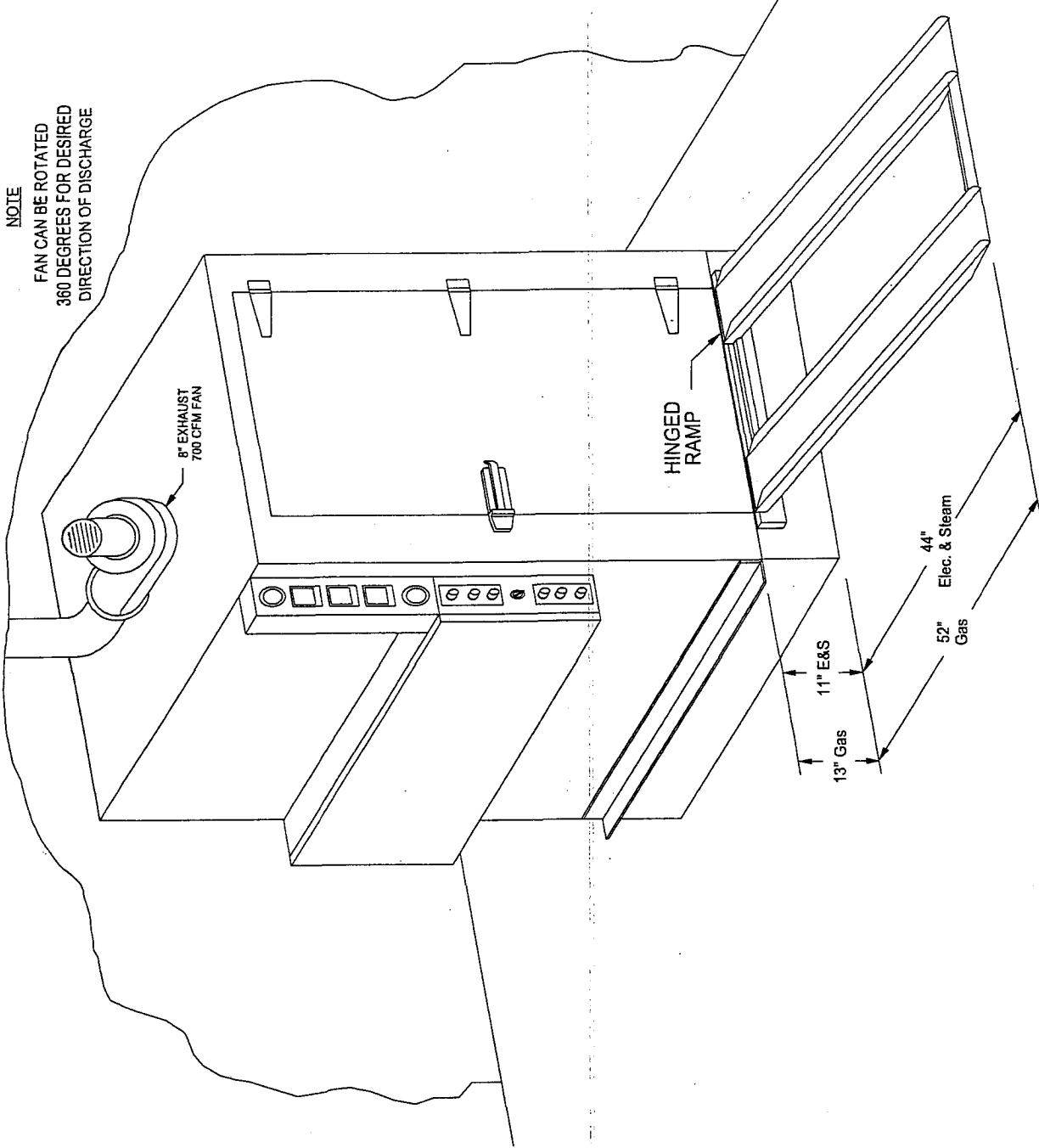

Philadelphia, PA 19135 PHONE (215) 624-4800 FAX (215) 624-6966		MAT.	GA.	NAME:
				SW-48-RI
			<i>M. Elbers</i>	FLOOR MODEL (NO LEGS)
SCALE	TOL. +	-	05-14-01	NO. 130-1130

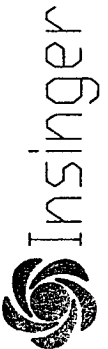

NOTE RECOMMENDED CLEARANCES

TOP	36"
FRONT	36"
SIDES	16"
(CONTROL BOX SIDE)	36"
REAR	12"
BOTTOM	6" *

WATER CONN. - 1" COPPER UNION
 GAS CONN. - 1/2" NPT MALE PIPE

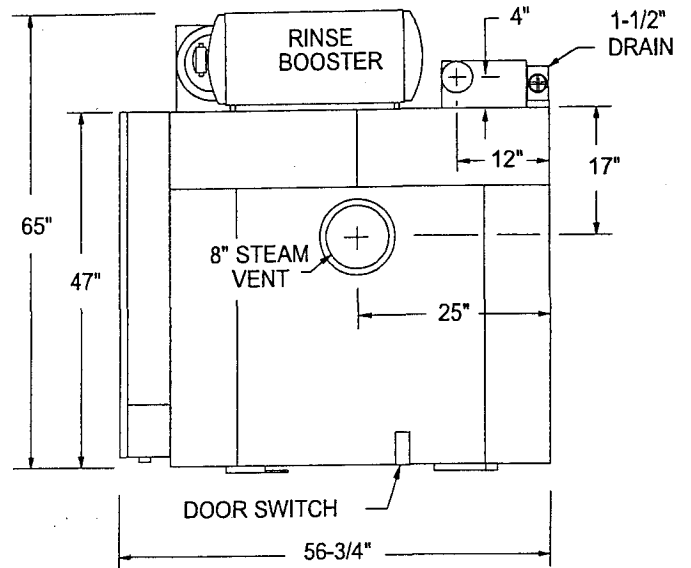

TOP VIEW

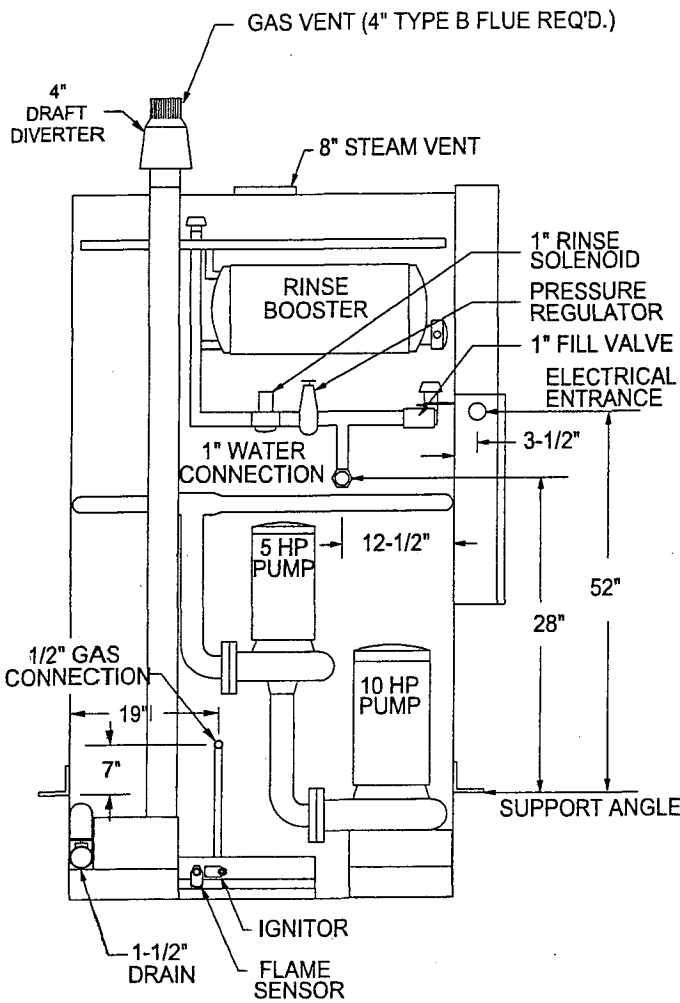

REAR VIEW

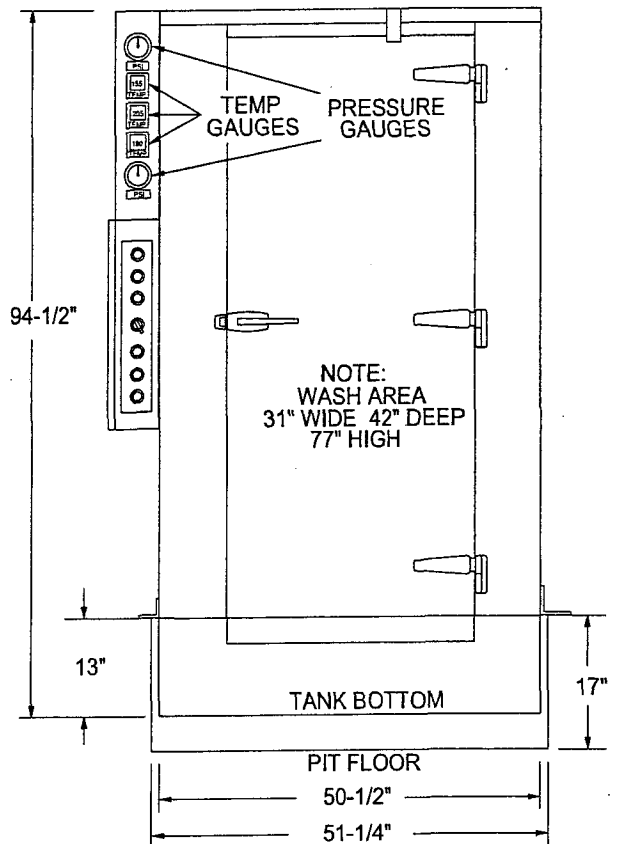

FRONT VIEW



Philadelphia, PA 19135

PHONE (215) 624-4800 FAX (215) 624-6966

MAT.	GA.	NAME	INFORMATIVE
Rev. 6-25-05	SCALE	SW-48-RI-G GAS	
TOL +	05-10-93	NO.	130-1105
-	M. Elbers		

NOTE RECOMMENDED CLEARANCES

TOP	36"
FRONT	36"
SIDES	16"
(CONTROL BOX SIDE)	36"
REAR	12"

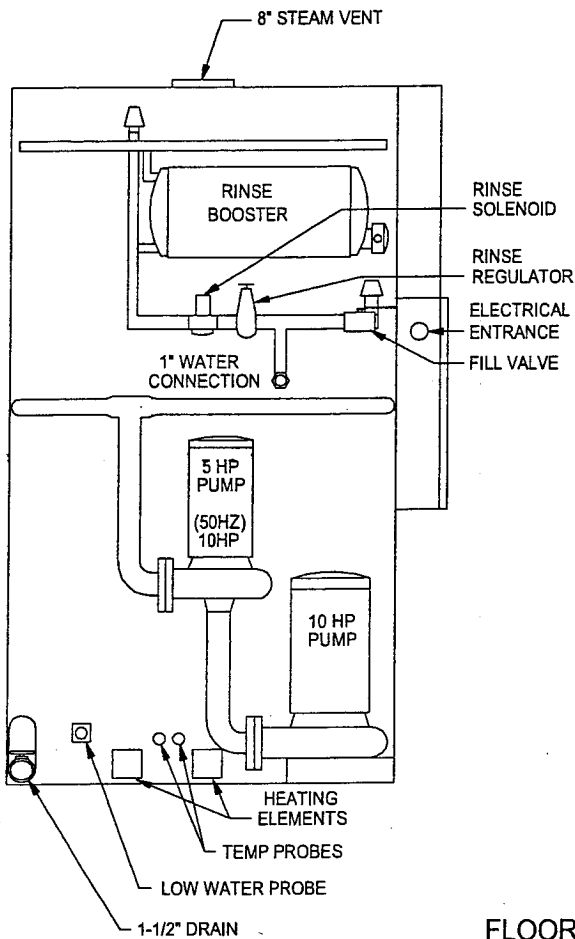
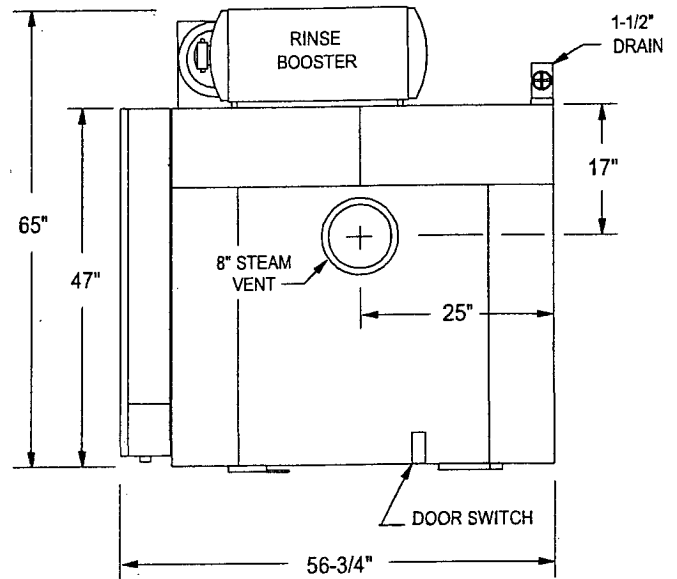

FLOOR MODEL

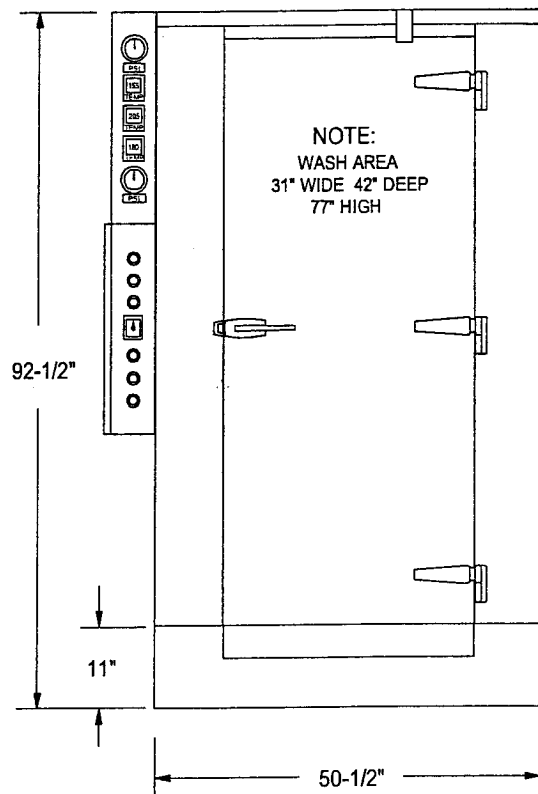

NOTE:
WASH AREA
31" WIDE 42" DEEP
77" HIGH



Philadelphia, PA 19135

PHONE (215) 624-4800

FAX (215) 624-6966

MAT.		GA.	NAME: INFORMATIVE
REV.	SCALE		SW-48-RI-E ELECTRIC
	TOL +	05-11-93	
	-	M. Elbers	NO. 130-1101

NOTE RECOMMENDED CLEARANCES

TOP	36"
FRONT	36"
SIDES	16"
(CONTROL BOX SIDE)	36"
REAR	12"

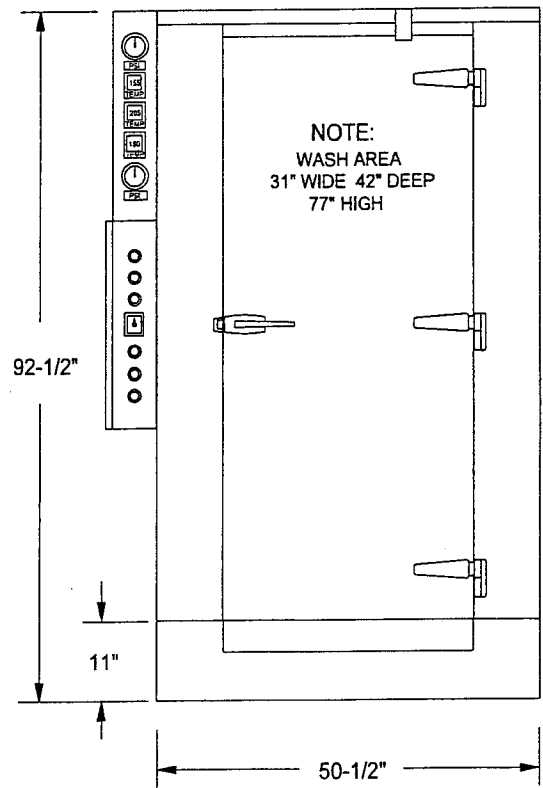
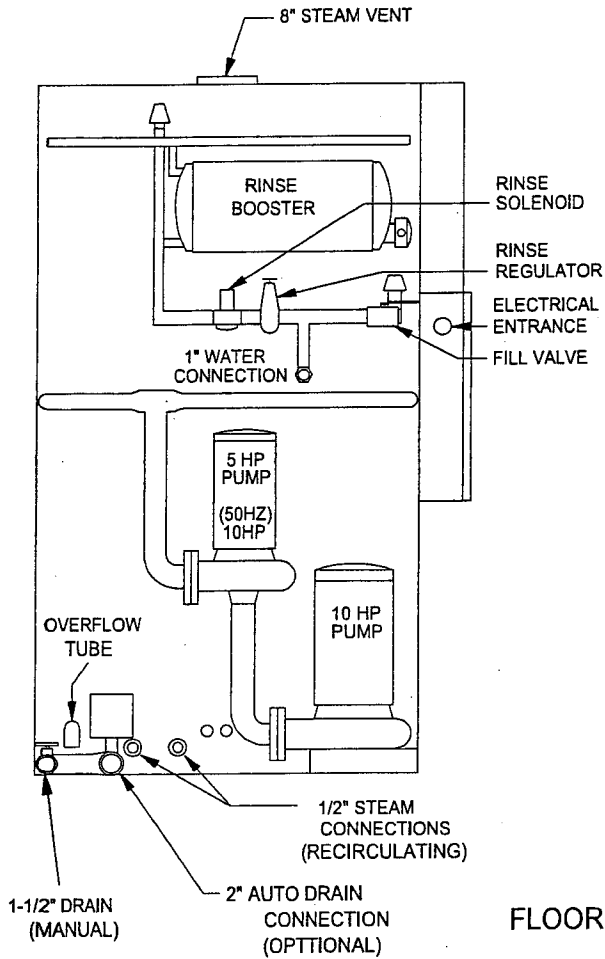
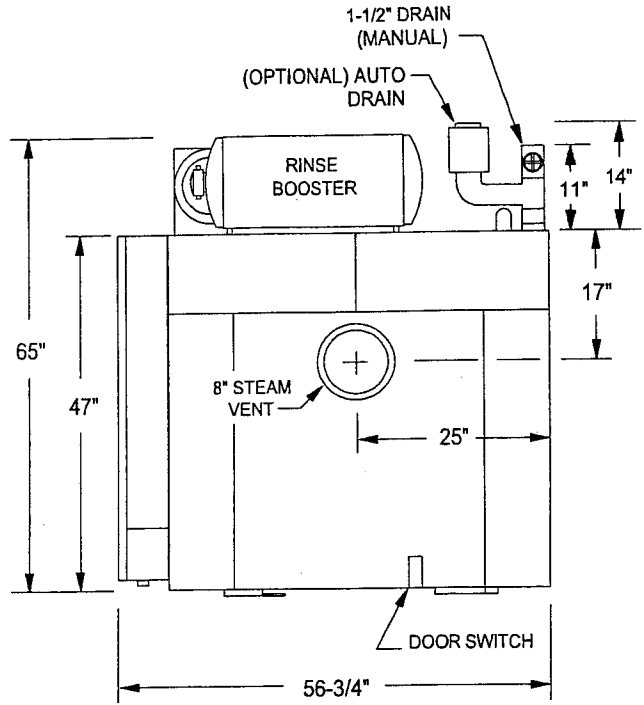

FLOOR MODEL



Philadelphia, PA 19135

PHONE (215) 624-4800 FAX (215) 624-6966

MAT.		GA.	NAME: INFORMATIVE
REV.	SCALE		SW-48-RI-S STEAM
	TOL +	06-03-95	
	-	M. Elbers	NO. 130-1102

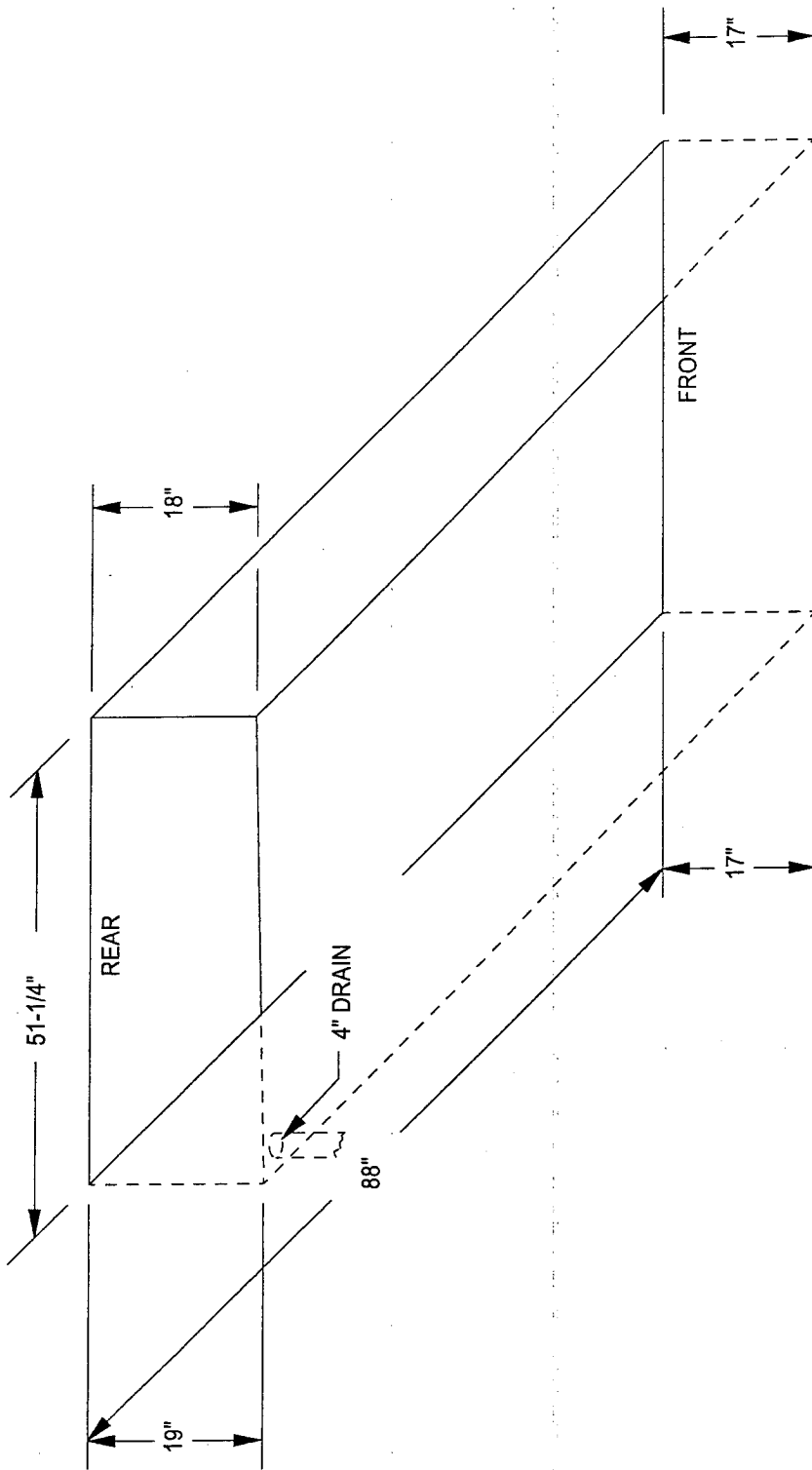

NOTE
 88" LENGTH INCLUDES 12" FOR ONE
 12" FRONT FLOOR GRATE AND 9"
 FOR REAR FLOOR GRATE
 FOR GAS AND ELECTRIC MODELS
 ADD 12" TO PIT LENGTH FOR EACH
 ADDITIONAL FRONT GRATE ORDERED



Insinger
 Philadelphia, PA 19135

PHONE (215) 624-4800 FAX (215) 624-6966

MAT.		GA.	NAME	INFORMATIVE
REV.	SCALE		SW-48-RI-PIT E, G, S.	
06-10-02	TOL +	02-15-00	NO.	130-1103
	-	<i>M. Elbers</i>		

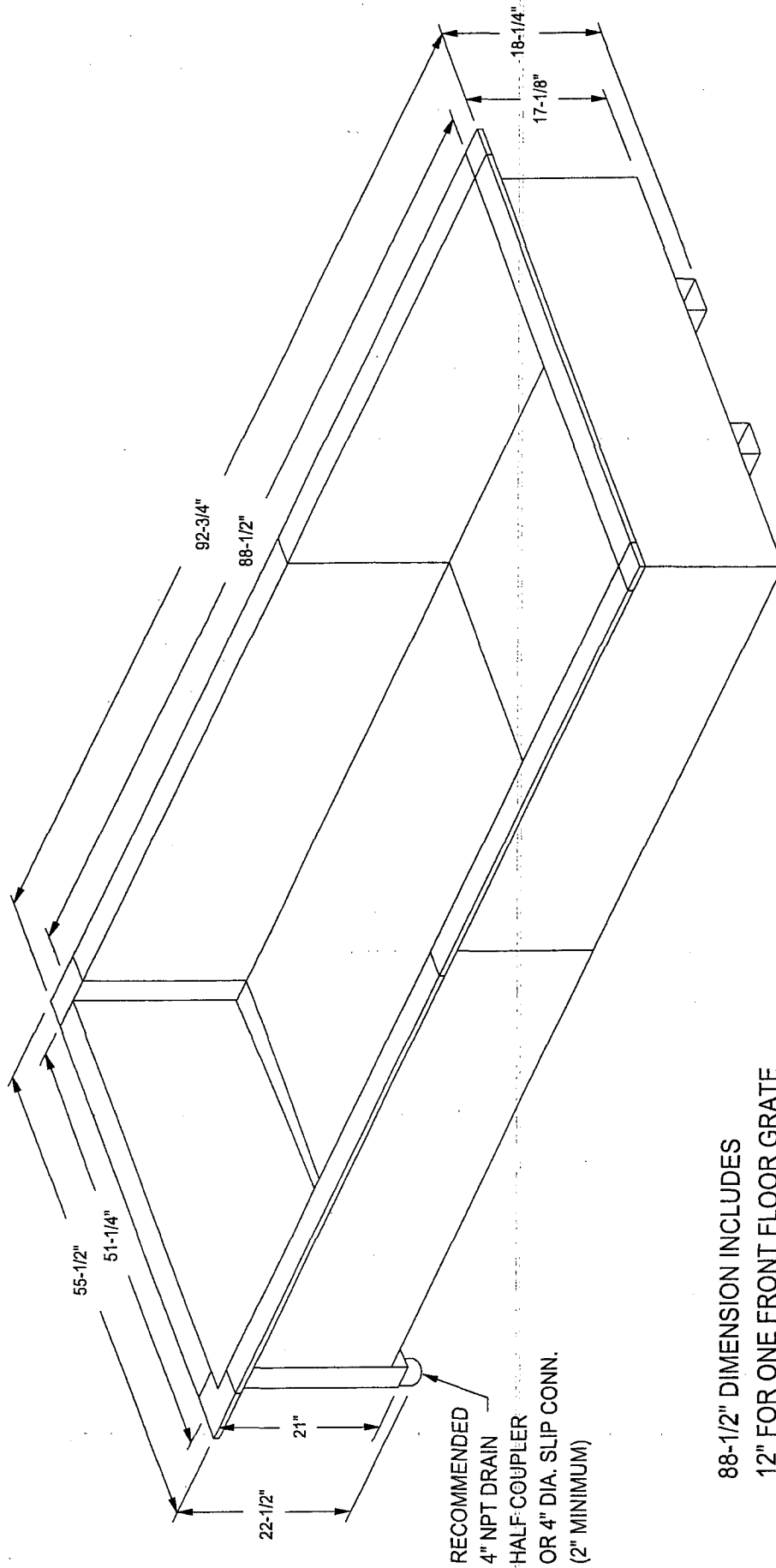

88-1/2" DIMENSION INCLUDES
12" FOR ONE FRONT FLOOR GRATE
AND 9" FOR ONE REAR GRATE

12" EXTRA PIT LENGTH REQUIRED
FOR EACH ADDITIONAL FRONT GRATE

NOTE: TO BE PLACED IN FLOOR &
CEMENT POURED AROUND PERIMETER

 Philadelphia, PA 19135 PHONE (215) 624-4800 FAX (215) 624-6966	MAT.	GA.	NAME: STAINLESS PIT
	SCALE	TOL. + -	SW-48-RI (1 FLOOR GRATE)
		<i>M. Elbers</i>	NO. 130-1114

OPTIONAL STAINLESS PIT LINER WITH ONE FRONT FLOOR GRATE

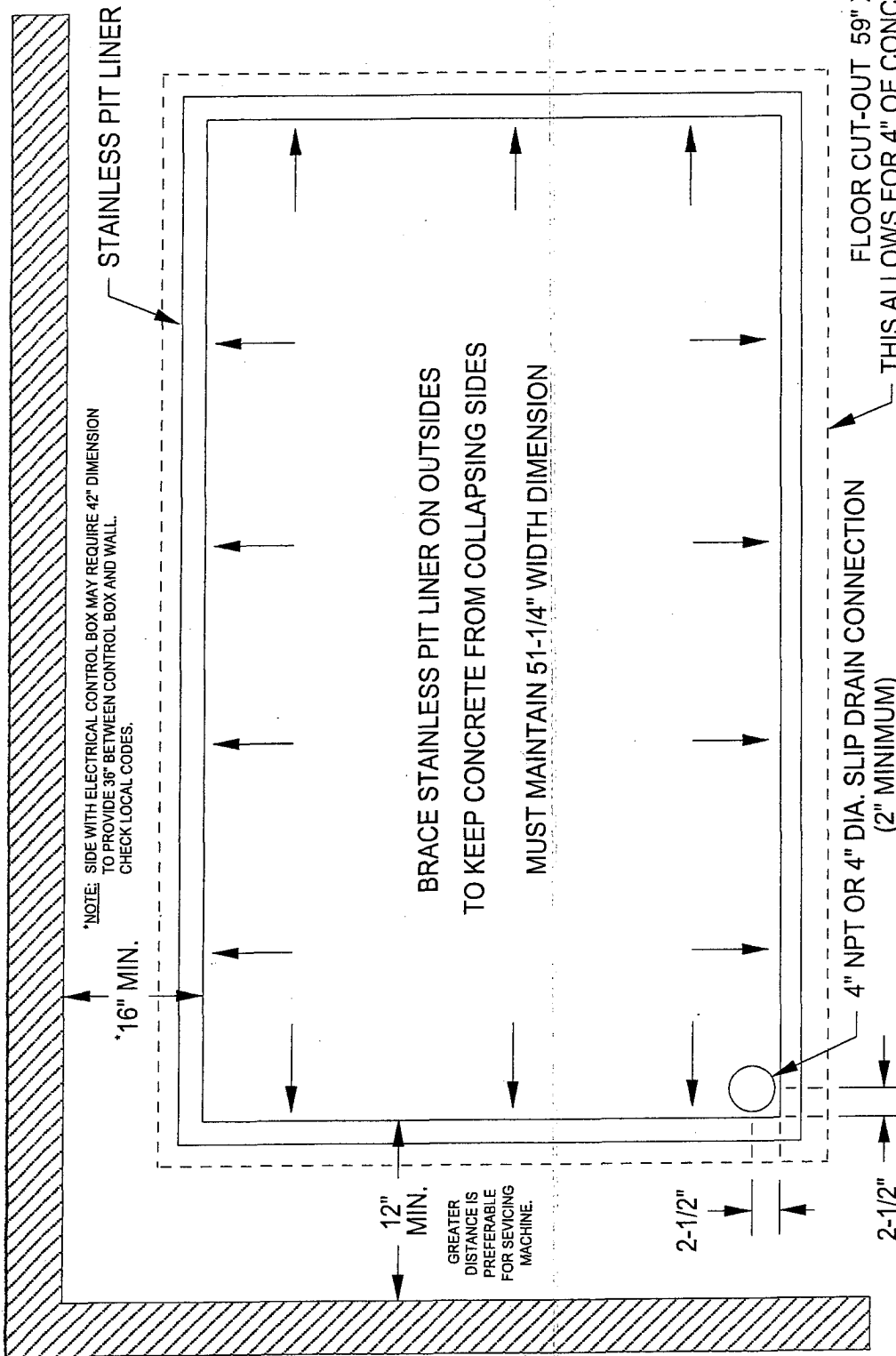

NOTE: ALL DIMENSIONS ARE FOR STANDARD PIT
CONSULT FACTORY FOR ANY CHANGES OR INFORMATION

FLOOR CUT-OUT 59" X 96"
THIS ALLOWS FOR 4" OF CONCRETE TO BE
POURED AROUND PIT LINER
(NOTE: ADD 12" TO LENGTH FOR EACH
ADDITIONAL FRONT GRATE)

 Philadelphia, PA 19135 PHONE (215) 624-4800 FAX (215) 624-6966	MAT.	GA.	NAME: INFORMATIONAL SW-48-RI
	SCALE	TOL. +	PIT WITH STAINLESS LINER
			NO. 130-1108

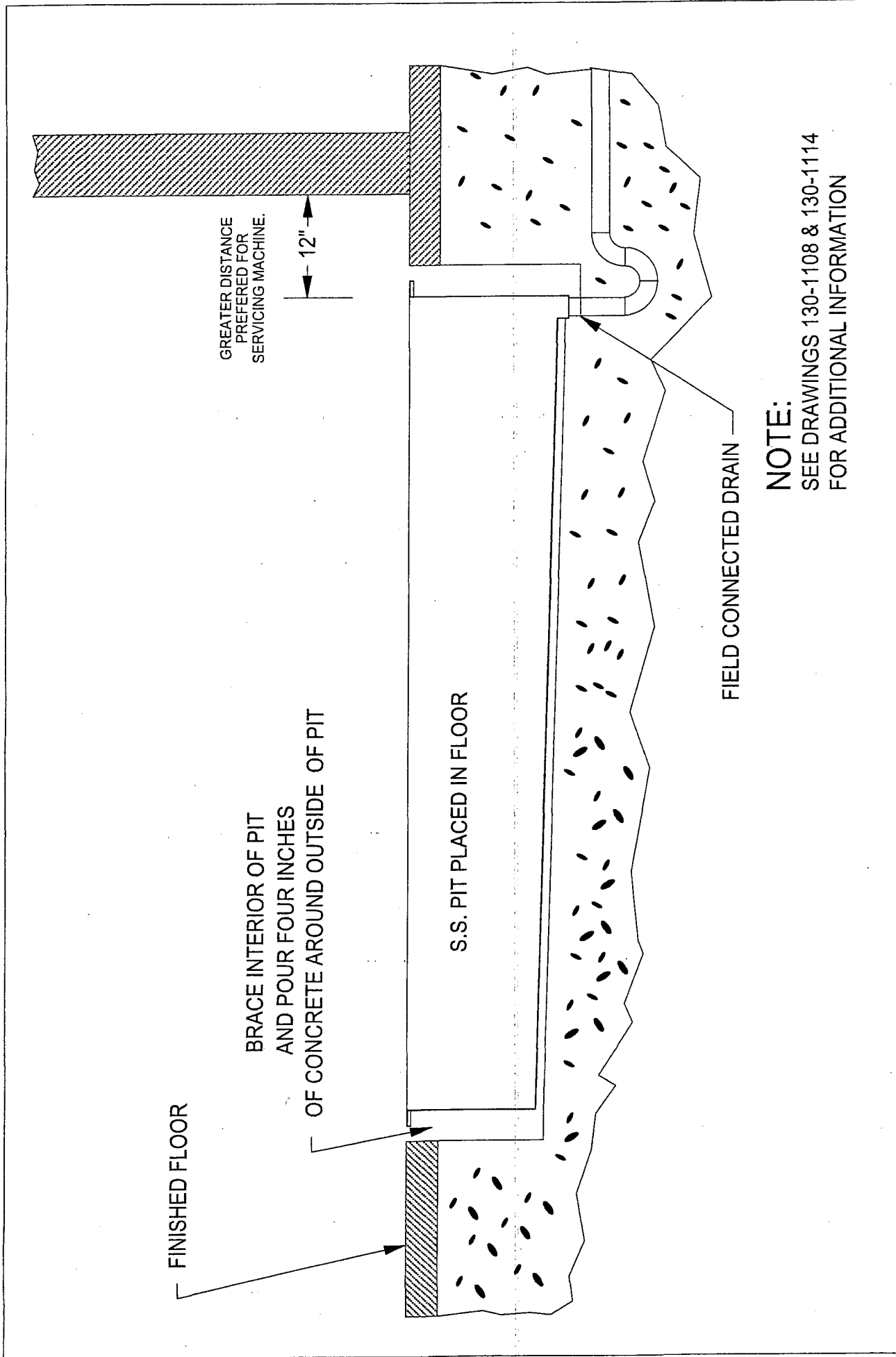

NOTE:

SEE DRAWINGS 130-1108 & 130-1114
FOR ADDITIONAL INFORMATION

Philadelphia, PA 19135 PHONE (215) 624-4800 FAX (215) 624-6966		MAT.	GA.	NAME:	S.S. PIT INFORMATIVE
			07-25-99		SW-48-RI
SCALE	TOL. +	-	<i>M. Elbers</i>	NO.	130-1110

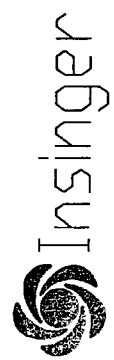

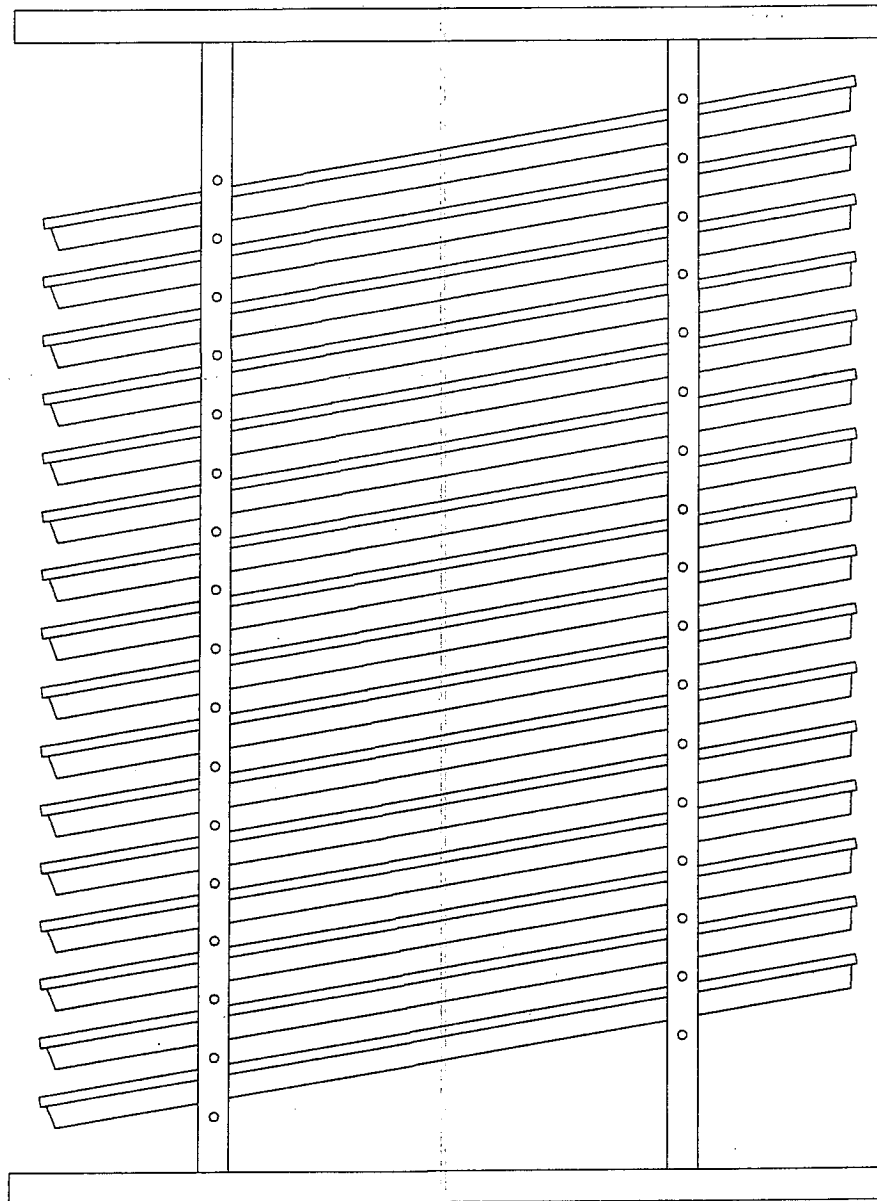

TOP VIEW OF BUN PAN RACK

LOAD ALL PANS FACING SAME DIRECTION

 Insinger Philadelphia, PA 19135 PHONE (215) 624-4800 FAX (215) 624-6966	MAT.		GA.	NAME	BUN PAN RACK	
	REV.	SCALE		SW-48-RI	INFORMATIVE	
		TOL	+	02-18-97		
			-	<i>M. Elbers</i>	NO.	BPR-INF

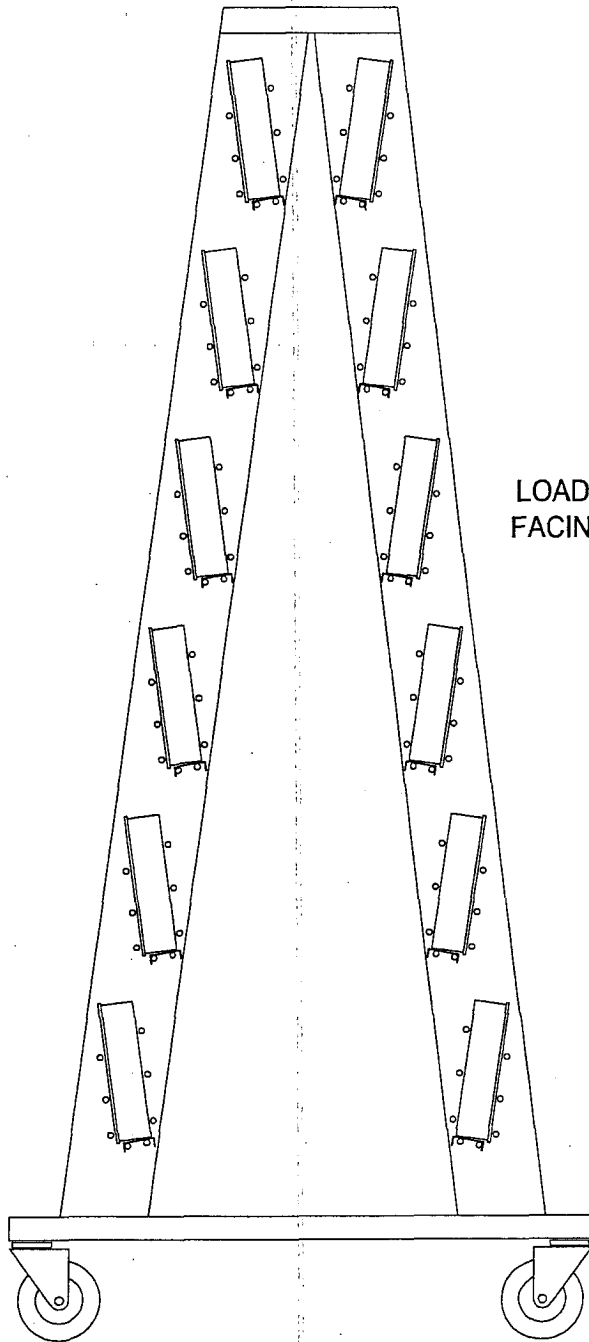

LOAD PANS
FACING OUT



Insinger

Philadelphia, PA 19135

PHONE (215) 624-4800 FAX (215) 624-6966

MAT.		GA.	NAME	CAKE PAN RACK
REV.	SCALE		SW-48-RI	INFORMATIVE
	TOL +	02-12-97		
	-	<i>M. Elbers</i>	NO.	CPR-INF

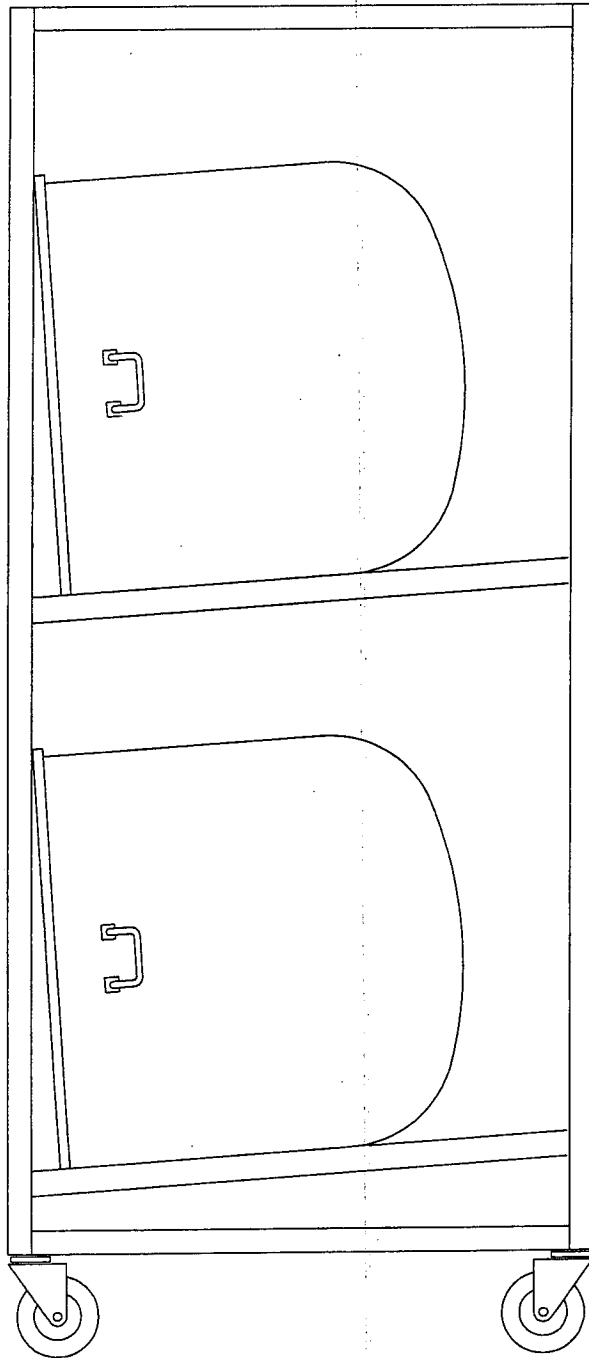

BOWLS SHOULD BE
LOADED TOP FIRST
TO ALLOW WATER
TO DRAIN OUT



Philadelphia, PA 19135

PHONE (215) 624-4800

FAX (215) 624-6966

MAT.		GA.	NAME	BOWL RACK
REV.	SCALE		SW-48-RI	INFORMATIVE
	TOL ⁺	02-12-97		
	-	M. Elbers	NO.	BR-INF

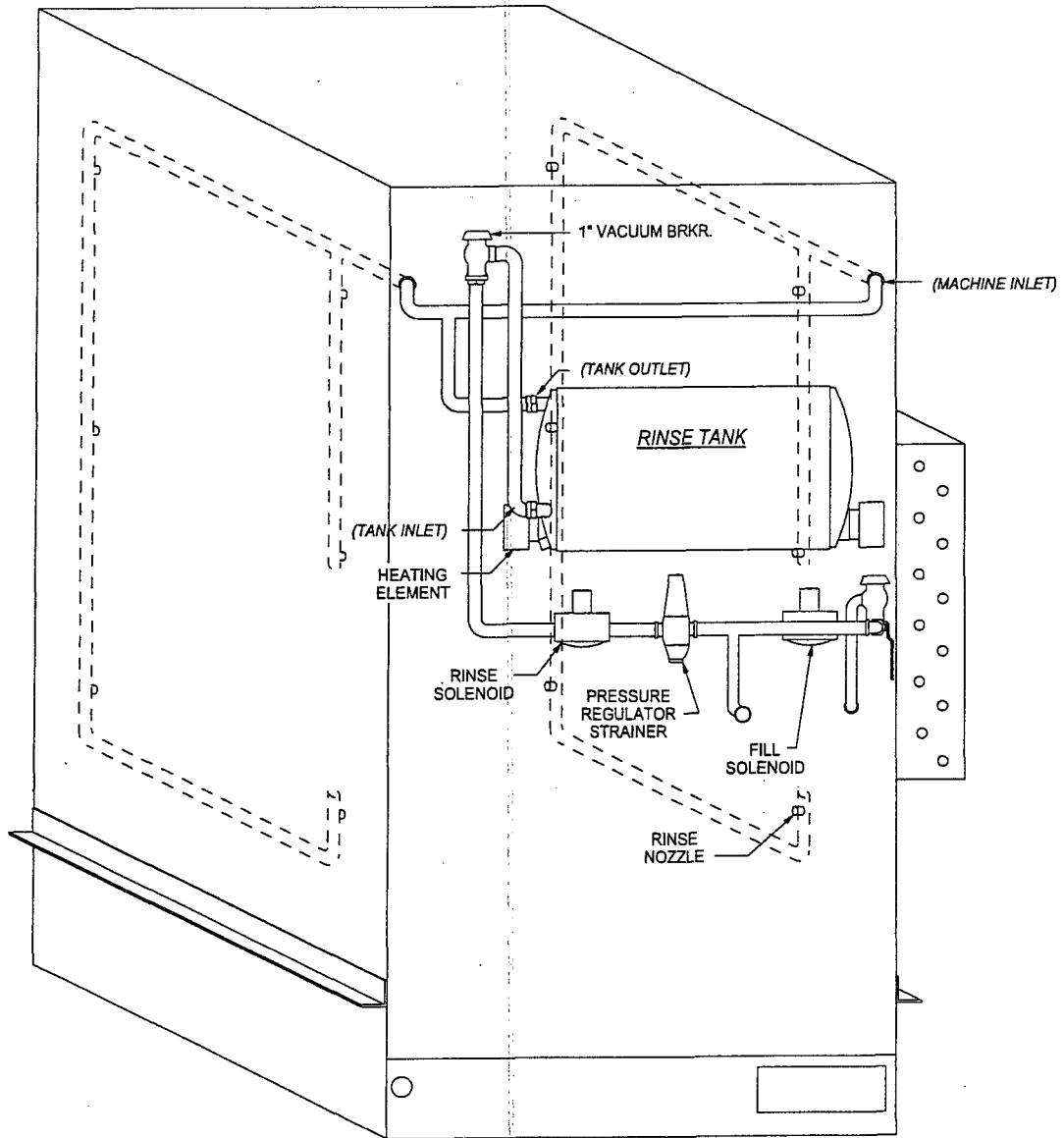

Philadelphia, PA 19135

PHONE (215) 624-4800

FAX (215) 624-6966

MAT.		GA.	NAME RINSE SYSTEM
REV.	SCALE		SW-48-RI INFORMATIVE
	TOL +	09-21-02	
	-	M. Elbers	NO. 130-1117

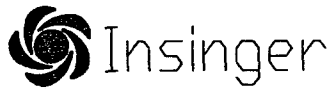
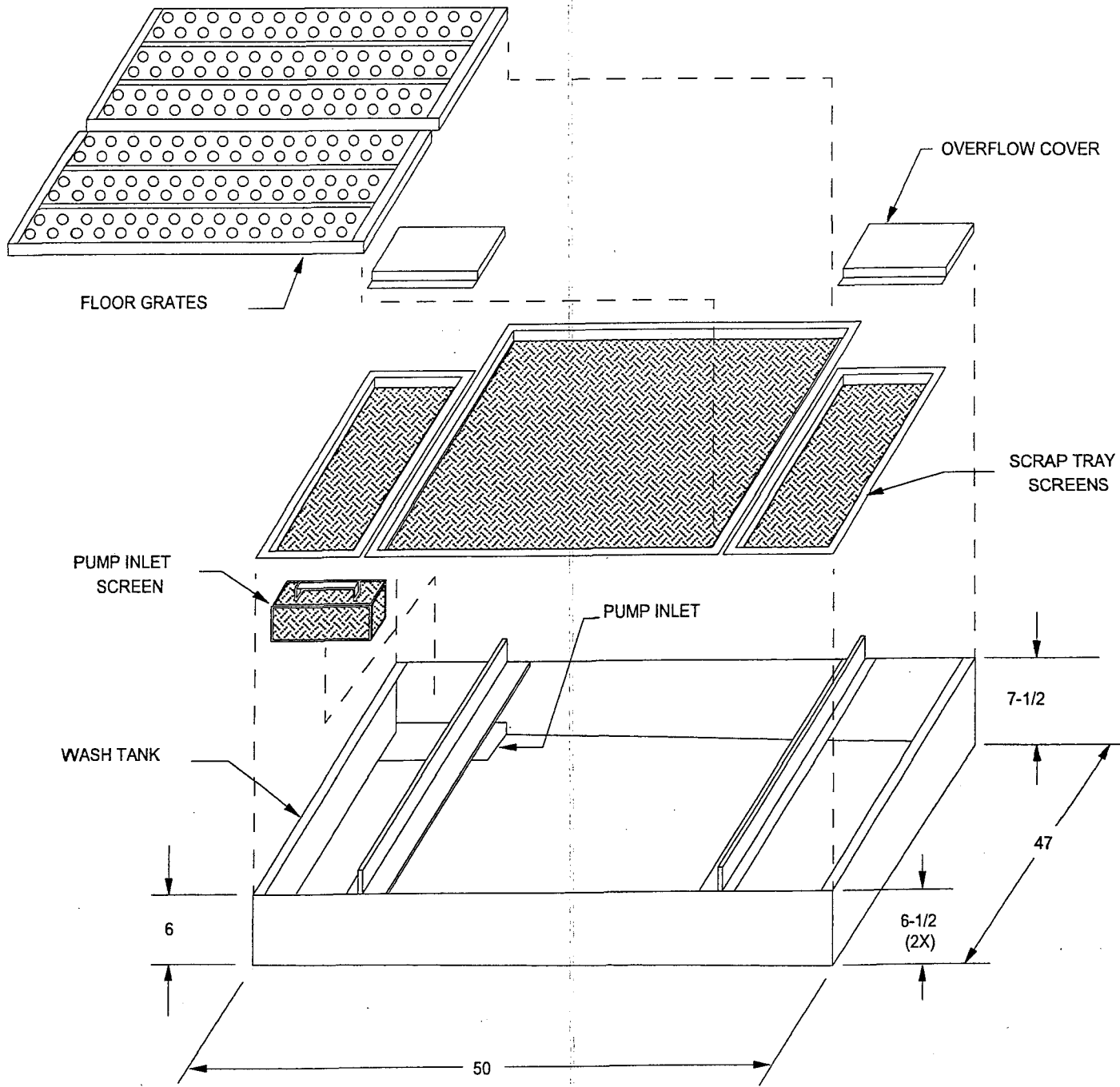

Philadelphia, PA 19135

PHONE (215) 624-4800

FAX (215) 624-6966

MAT.

REV.

SCALE

TOL +
-

GA.

02-17-97

M. Elbers

NAME

GRATE & SCREEN

INFORMATIVE

NO.

130-1107

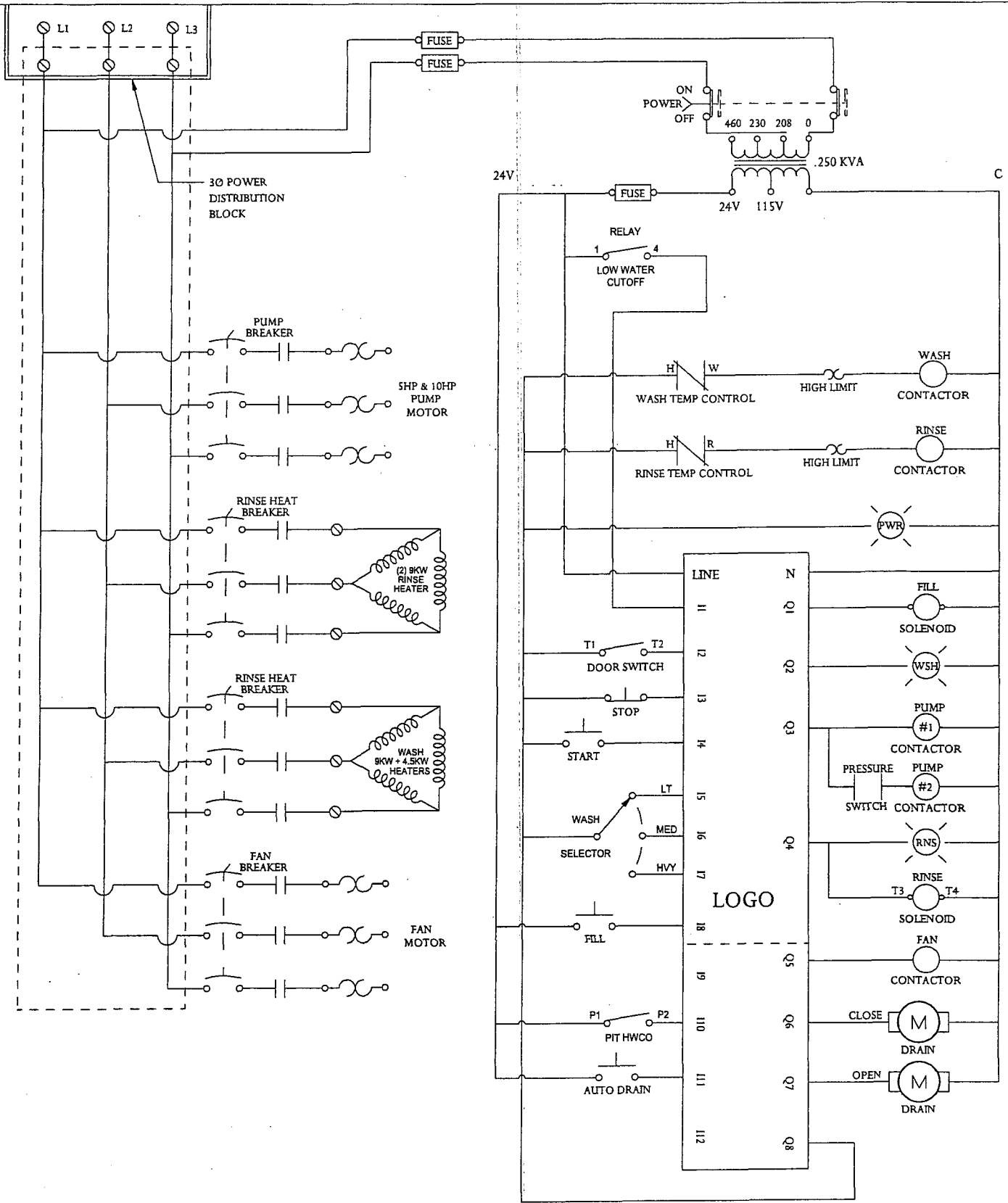

WITH (OPT.) AM FAN, AUTO FILL, AUTO DRAIN, PIT PROTECTION



Philadelphia, PA 19135

PHONE (215) 624-4800 FAX (215) 624-6966

MAT.		GA.	NAME: 24V ELEC. SCHEMATIC
REV.	SCALE		SW-48-RI-E AF-AD-AM-PF
	TOL +	08-21-07	
	-	C. Woiwood	NO. 124L1150

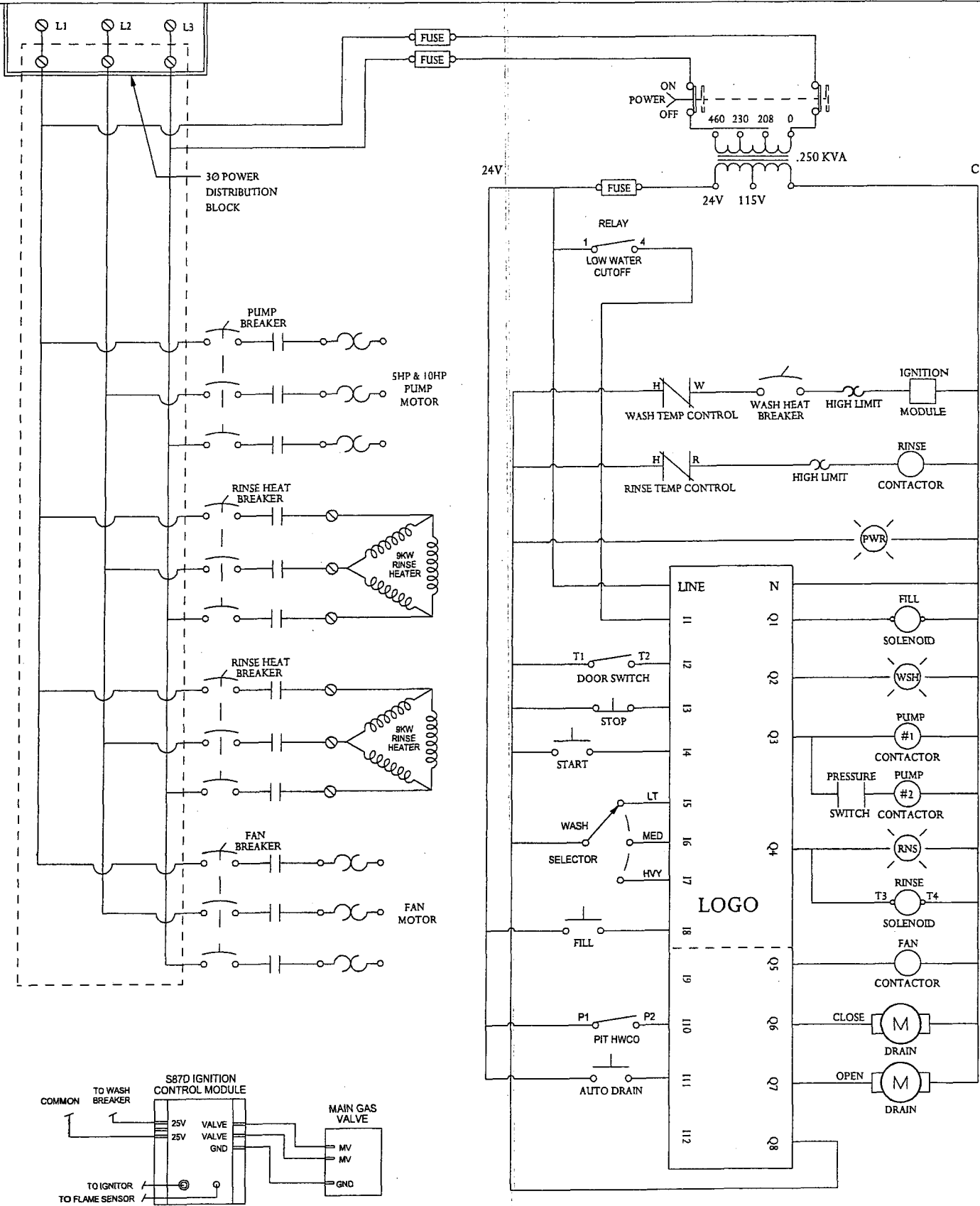

WITH AM FAN, AUTO FILL, AUTO DRAIN, PIT PROTECTION



Philadelphia, PA 19135

PHONE (215) 624-4800 FAX (215) 624-6966

MAT.		GA.	NAME: 24V ELEC. SCHEMATIC
REV.	SCALE		SW-48-RI-G AF-AD-AM-PF
	TOL +	08-21-07	
	-	C. Woivood	NO. 124L1155

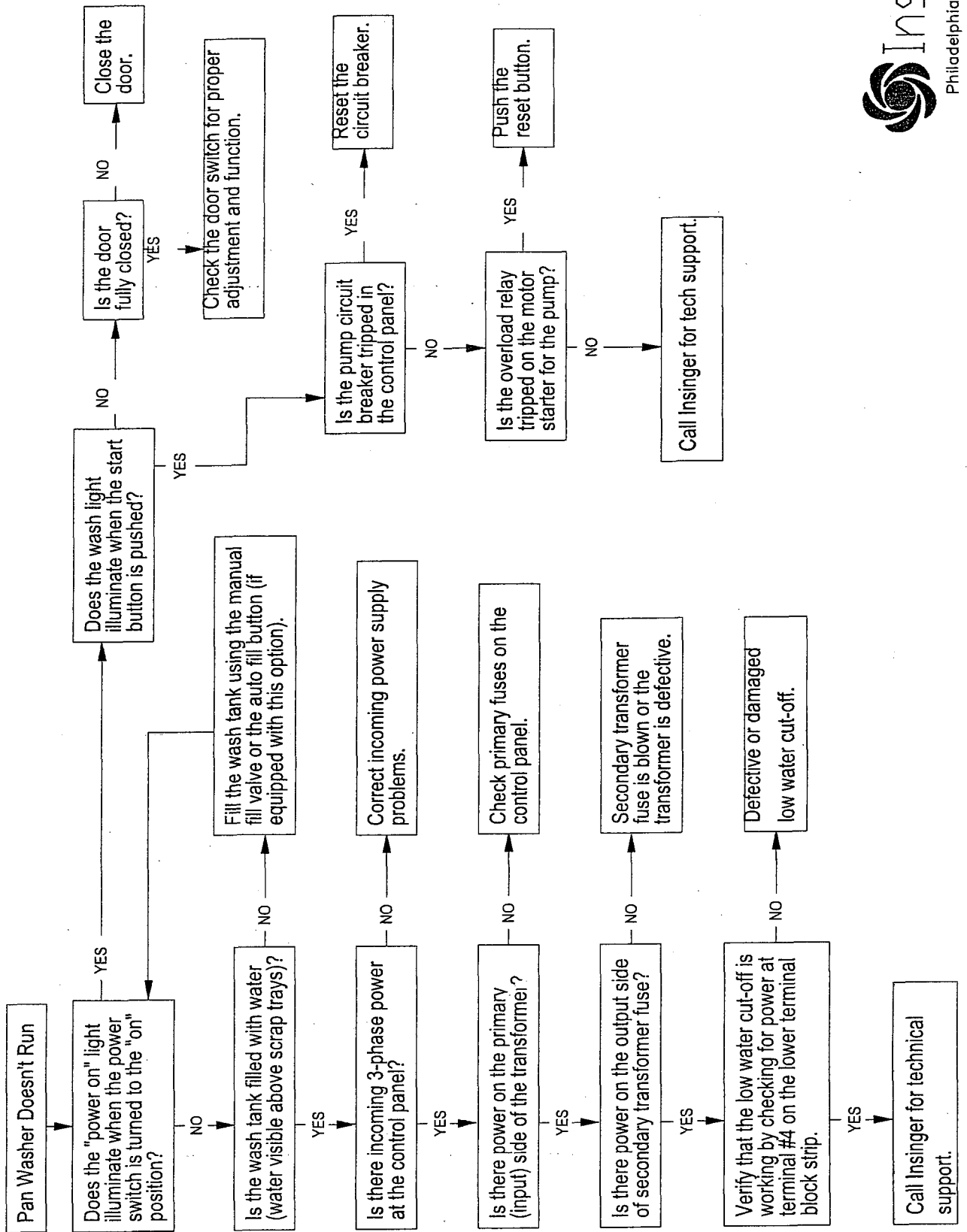

HOURS OF OPERATION

Insinger is available to assist you and your team day or night. Our regular business hours are Monday through Friday, 8:00 AM - 5:00 PM (EST). After-hours inquiries may take longer to respond.

CONTACTS

SALES

Kim Croft
Director of Business Development
E: kcroft@insingermachine.com
D: (215) 624-4800 x124
C: (630) 400-3656

David Baysinger
Regional Sales Manager
E: dbaysinger@insingermachine.com
D: (215) 624-4800 x111

ORDERS & QUOTES

Edward Gerhard
Account Manager
E: egerhard@insingermachine.com
D: (215) 624-4800 x116

Deniece Heard
Customer Service
E: dheard@insingermachine.com
D: (215) 624-4800 x120

MARKETING

Matthew Weisbecker
Strategic Marketing Manager
E: mweisbecker@insingermachine.com
D: (215) 624-4800 x131

SERVICE & SUPPORT

Jason Striker
Parts & Service Manager
E: jason@insingermachine.com
D: (215) 624-4800 x139

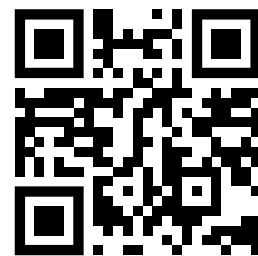

Digital Contact Cards

